

CONVEY-ALL[®]

CST-39C

COMMERCIAL SEED TENDER



convey-all.com/cst-39c



OPERATOR'S MANUAL

**PRODUCT REGISTRATION FORM
and INSPECTION REPORT**

CONVEY-ALL®

The Dealer must fill out this form, and be signed by both the Dealer and Buyer at the time of delivery. Scan or photograph the completed form (must be legible), and email it to: register@convey-all.com
A copy of this form may also be mailed to: Box 760, 275 Hespler Ave, Winkler Manitoba R6W 4A8.

Buyer's Name _____	Dealer's Name _____
Address _____	Address _____
City _____	City _____
Province/State _____	Province/State _____
Postal/Zip Code _____	Postal/Zip Code _____
Country _____	Country _____
Phone Number _____	Phone Number _____
Model Number _____	Serial Number _____
Delivery Date _____	General Purpose: <input type="checkbox"/> Private <input type="checkbox"/> Commercial

UNIT INSPECTION

- No paint damage, scratches, or corrosion
- No hydraulic oil leaks, fuel leaks, air leaks
- Checked engine/hydraulic fluid levels
- Hydraulic Hoses Secure and Fittings Tight
- Conveyor Belts Move Freely
- Conveyor Belts Aligned and Tensioned
- Rear, Fold Conveyor Moves Freely. Limit Switches function correctly
- Gate Cylinders and Limit Switches Function Correctly

SAFETY INSPECTION

- All Guards/Shields Installed and Secured
- All Safety Decals Clear and Legible
- Reflectors are Clean
- All Lights are Clean and Working
- Reviewed Operating/Safety Instructions

I have thoroughly instructed the buyer on the above described equipment. The review included the content of the Operator's Manual, equipment care, adjustments, safe operation and warranty policy.

Date _____ Dealer's Signature _____

The above equipment and Operator's Manual have been received by me. I have been thoroughly instructed as to care, adjustments, safe operation and applicable warranty policy.

Date _____ Buyer's Signature _____

This page intentionally left blank

TABLE OF CONTENTS

DESCRIPTION	PAGE
Section 1: INTRODUCTION	1-1
Section 2: SAFETY	2-1
2.1 Safety Orientation	2-2
2.2 General Safety	2-2
2.3 Equipment Safety Guidelines	2-3
2.4 Safety Decals	2-3
2.4.1 How to Install Safety Signs	2-3
2.5 Decal Location	2-4
2.6 Work Preparation	2-6
2.7 Placement Safety	2-6
2.8 Lock-Out Tag-Out Safety	2-6
2.9 Engine Safety	2-7
2.10 Maintenance Safety	2-8
2.11 Tire Safety	2-8
2.12 Battery Safety	2-9
2.13 Hydraulic Safety	2-9
2.14 Operating Safety	2-10
2.15 Workplace Hazard Area	2-11
2.16 Transport Safety	2-12
2.17 Storage Safety	2-12
Section 3: OPERATION	3-1
3.1 Machine Components	3-2
3.2 Components and Controls	3-3
3.3 Machine Break-In	3-9
3.4 Pre-Trip Inspection	3-9
3.5 Pre-Operation Inspection	3-9
3.6 Wireless Handset Functions	3-10
3.7 Rear Conveyor Shuttle Movement	3-11
3.8 Operating on Site	3-13
3.9 Storage	3-17
3.10 Removing from Storage	3-17

continued on next page

TABLE OF CONTENTS

DESCRIPTION	PAGE
Section 4: SERVICE AND MAINTENANCE	4-1
4.1 Fluids and Lubricants	4-1
4.1.1 Greasing	4-2
4.2 Servicing Intervals.	4-3
4.2.1 Every 10 Hours or Daily.	4-3
4.2.2 Every 50 Hours or Weekly.	4-4
4.2.3 Every 100 Hours or Monthly	4-5
4.2.3 Every 200 Hours or Annually.	4-6
4.3 Maintenance Procedures	4-7
4.3.1 Conveyor Belt Tension	4-7
4.3.2 Conveyor Belt Alignment	4-8
4.3.3 Conveyor Belt Replacement	4-9
4.3.4 Changing Hydraulic Oil	4-10
4.3.5 Changing Hydraulic Filter	4-10
4.4 Service Record	4-11
Section 5: TROUBLESHOOTING.	5-1
Section 6: REFERENCE.	6-1
6.1 Bolt Torque	6-2
Warranty Statement	

Section 1: INTRODUCTION

Thank you for choosing a Convey-All® Commercial Seed Tender (CST).

Convey-All® products are built by Meridian Manufacturing Inc. The equipment we design and manufacture meet the exacting standards of the agriculture industry.

Keep this manual for future reference. Call your dealer, distributor or Meridian if you need assistance, information, additional/replacement copies, or a digital copy of this document.

Information provided herein is of a descriptive nature. Meridian Manufacturing Inc. reserves the right to modify the machinery design and specifications without any preliminary notice.

Performance quality may depend on the material being handled, weather conditions and other factors.

OPERATOR ORIENTATION

The directions; left, right, front and rear, as mentioned throughout this manual, are as seen from the truck driver's seat and facing the direction of travel. **Note:** Engine, hydraulics and other equipment may be installed either on the right or left side of the tender.

SERIAL NUMBER LOCATION

Always give your dealer the serial number when ordering parts, requesting service, or asking for other information. The tender's serial number is on the rear support.

Use the space provided for easy reference:

Tender Serial No: _____

Engine Serial No: _____

Trailer Plate No: _____

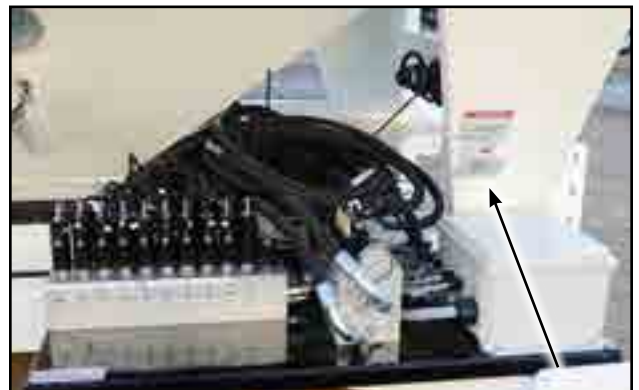

Fig 1 - Serial # on rear, left-side, vertical beam



Meridian Manufacturing Inc. continuously enhances its product offering through product improvements and new product innovations. Marketplace feedback, technological innovation, new materials and manufacturing methods, and a philosophy of continuous improvement constantly challenge the company to develop new and better ways of addressing market needs. Meridian is committed to innovation and reinvestment and as a result, the company maintains a portfolio of patents and intellectual property. For more information on our patents please see our website:

www.convey-all.com/patents

Section 2: SAFETY

3 Big Reasons why safety is important to you:

- Accidents Disable and Kill
- Accidents Cost
- Accidents Can Be Avoided

The Safety Alert Symbol means:



ATTENTION!
BECOME ALERT!
YOUR SAFETY IS INVOLVED!

The Safety Alert Symbol identifies important safety messages on the tender and in this manual.

The following signal words are used in this manual to express the degree of hazard for areas of personal safety.

When you see the symbol and/or the signal words described below, obey the accompanying message to avoid possible injury or death.



Indicates a hazardous situation that, if not avoided, will result in death or serious injury. This signal word is limited to the most extreme situations. Typically for machine components which, for functional purposes, cannot be guarded.



Indicates a hazardous situation, if not avoided, could result in death or serious injury. This word identifies hazards that are exposed when guards are removed. It may be used to alert against unsafe practices.



Indicates a hazardous situation, if not avoided, could result in minor or moderate injury. It may be used to alert against unsafe practices.



Indicates practices or situations which may result in the malfunction of, or damage to equipment.



Safety instructions (or equivalent) signs indicate specific safety-related instructions or procedures.

2.1 SAFETY ORIENTATION

YOU are responsible for the SAFE operation and maintenance of your Convey-All[®] Commercial Seed Tender (CST). Be sure that you and anyone else who will operate, maintain or work around the tender be familiar with the safety, operating and maintenance procedures.

This manual will take you step-by-step through your working day and alerts you to all good safety practices that should be adhered to while operating the CST.

Remember, you are the key to safety. Good safety practices not only protect you but also the people around you. Make these practices a regular part of your safety program. Be certain that everyone who will work with this equipment follows these procedures.

Most accidents can be prevented. Do not risk injury or death by ignoring good safety practices.

- Tender owners must give operating instructions to operators or employees before allowing them to operate the machine.

Procedures must be reviewed annually thereafter per OSHA (Occupational Safety and Health Administration) regulation 1928.57.

- The most important safety device on this equipment is a SAFE operator. It is the operator's responsibility to understand all safety and operating instructions in the document, and to follow them.
- An untrained operator exposes himself and bystanders to possible serious injury and death.
- Think SAFETY! Work SAFELY!

2.2 GENERAL SAFETY

- Read and understand the Operator's Manual and all safety decals before operating, maintaining, adjusting or unplugging the tender. 

- Only trained, competent persons shall operate the unit. An untrained operator is not qualified to operate the machine.

- Have a first-aid kit available for use should the need arise. 

- Provide a fire extinguisher for use in case of an accident. Store in a highly visible place. 

- Do not allow riders.
- Do not allow children, spectators or bystanders within hazard area around the machine.

- Wear personal protective equipment (PPE). This list may include but is not limited to:

- Hard hat
- Protective shoes with slip resistant soles
- Eye protection
- Work gloves
- Hearing protection
- Respirator or filter mask
- Hi-Visibility safety vest

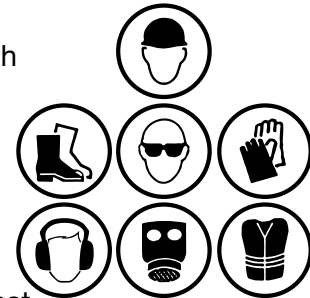

- Never use alcoholic beverages or drugs which can hinder alertness or coordination while operating this equipment.

Consult your doctor about operating this machine while taking prescription medications.

- If the elderly are assisting with farm work, their physical limitations need to be recognized and accommodated.
- Review safety related items annually with all personnel who will be operating or maintaining the tender.

2.3 EQUIPMENT SAFETY GUIDELINES

- Safety of the operator and bystanders is one of the main concerns in designing and developing equipment. However, every year many accidents occur which could have been avoided by a few seconds of thought and a more careful approach to handling equipment.
- Do not allow personnel to operate this unit until they have been trained. They must know all safety precautions.
- In order to provide a better view, some images in this manual may show an assembly with a safety guard removed.

Equipment should never be operated in this condition. All guards must be in place. If removal becomes necessary for repairs, replace the shield prior to use.



- This equipment is dangerous to children and persons unfamiliar with its operation.

The operator should be responsible, properly trained and physically able. You should be familiar with farm machinery in general.

- Never exceed the limits of a piece of machinery. If its ability to do a job, or to do so safely, is in question - DON'T TRY IT.
- Do not modify the equipment in any way. Unauthorized modification result in serious injury or death and may impair the function and life of the equipment.
- The design and configuration of this conveyor includes safety decals and equipment. They need to be clean, readable and in good condition.

2.4 SAFETY DECALS

- Keep safety decals clean and legible at all times.
- Replace safety decals that are missing or have become illegible.
- Replaced parts must display the same decal(s) as the original parts.
- All safety decals have a part number in the lower right hand corner. Use this part number when ordering replacements.
- Decals are available from your authorized distributor, dealer's parts department or from Meridian Manufacturing Inc.

2.4.1 Applying Decals:

1. Be sure the application area is clean and dry. Ensure the surrounding temperature is above 10°C (50°F).
 - a. Remove all dirt, grease, wax from surface.
 - b. Clean the area with a non-ammonia based cleaner.
 - c. Wipe the clean surface with isopropyl alcohol on paper towel, and allow to dry.
2. Determine the exact position before you remove the backing paper.
3. Peel a small portion of the split backing paper.
4. Align the decal over the specified area. Use a squeegee to carefully press the small portion, with the exposed adhesive backing, into place.
5. Slowly peel back the remaining paper and carefully smooth the rest of the decal into place.
6. Small air pockets can be pierced with a pin and smoothed out using the squeegee, or a piece of sign backing paper.

2.5 DECAL LOCATION

The following illustrations show the general location of decals on this conveyor. The position of decals may vary depending on the machine's options. Decals are not shown at actual size.

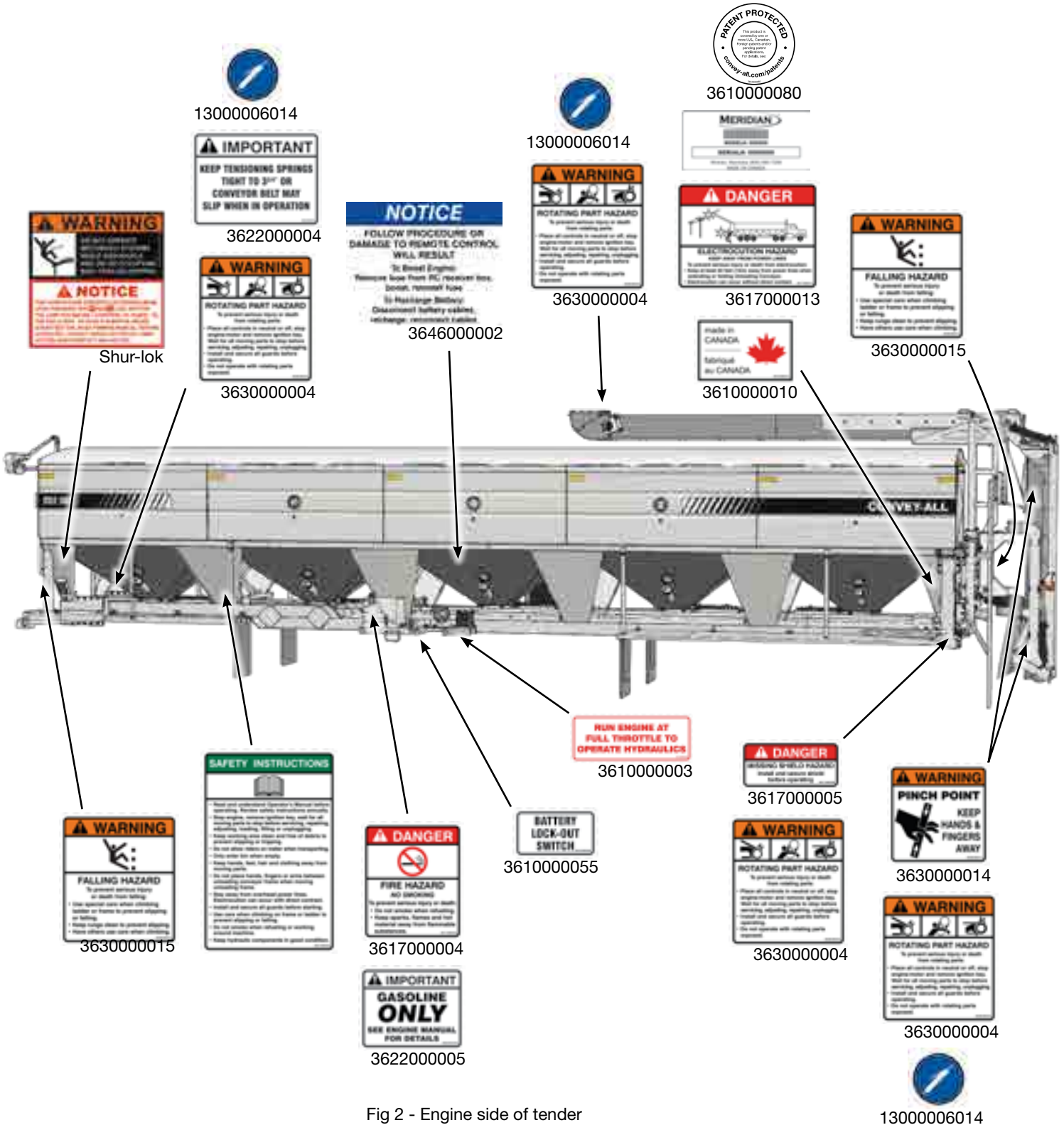
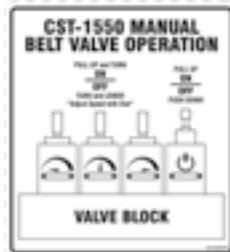

Fig 2 - Engine side of tender



3618000067

Valve decal is located on left-side (or right), rear compartment wall, above valves

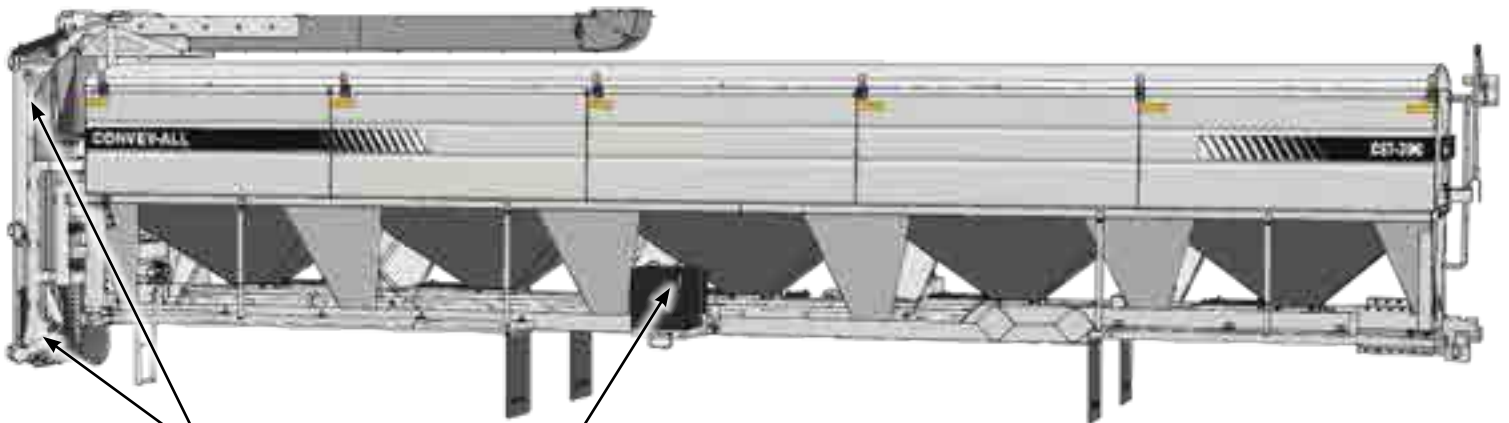

Fig 3 - Hydraulic Reservoir side of tender



3630000014



3630000004



13000006014



3610000011



3630000001

REMEMBER - If safety decals have been damaged, removed, become illegible, or parts were replaced without signage, new ones must be applied. New decals are available from your authorized dealer.

2.6 WORK PREPARATION

- Never operate the engine and CST until you have read this manual, and understand the information.

Also, read the engine operator's manual.

- Be familiar with the safety messages found on the decal around the unit.

- Personal protective equipment (PPE) including:
 - Hard hat
 - Eye protection
 - Protective shoes
 - Work gloves



They are recommended during operation, maintenance or when transporting the tender.

- Do not allow long hair, loose fitting clothing or jewelry to be around equipment.
- **PROLONGED EXPOSURE TO LOUD NOISE MAY CAUSE PERMANENT HEARING LOSS!**

Agricultural equipment can often be noisy enough to cause permanent, partial hearing loss. We recommend that hearing protection be worn on a full-time basis if the noise in the operator's position exceeds 80db.



Noise over 85db on a long-term basis can cause severe hearing loss.

Noise over 90db adjacent to the operator over a long-term basis may cause permanent, total hearing loss.

Note:

Hearing loss from loud noise (tractors, chain saws, radios, etc.) is cumulative over a lifetime without hope of natural recovery.

- Clear working area of stones, branches or hidden obstacles that might be hooked or snagged, causing injury or damage.
- Operate only in daylight or good artificial light.
- Be sure machine is in a stable position, is adjusted and in good operating condition.
- Ensure that all safety guards and safety decals are properly installed and in good condition.
- Before starting, inspect the unit for any loose bolts, worn parts, cracks, leaks and/or frayed belts. Make the necessary repairs.

Always follow maintenance instructions.



2.7 PLACEMENT SAFETY

- Stay away from overhead power lines when operating or moving the tender. Electrocutation can occur without direct contact.
- Store rear, fold conveyor over top of tender when moving. Unfold the conveyor only when ready to unload.
- Position tender providing enough space for truck to load and unload.
- Operate tender on level ground free of debris.

2.8 LOCK-OUT TAG-OUT SAFETY

- Establish a formal Lock-Out, Tag-Out program for your operation.
- Train all operators and service personnel before allowing them to work around the area.
- Provide tags on the machine and a sign-up sheet to record tag out details.

2.9 ENGINE SAFETY

- Read and understand the operating manual provided with the engine. 
- Use proper tools to service engine.
- Do not run engine in an enclosed area. Exhaust gases contain carbon monoxide, an odorless and deadly poison.
- Store fuel in approved safety containers.
- Do not store fuel near open flame. 

Appliances such as a stove, furnace, or water heater use a pilot light which can create a spark. 
- No smoking when filling fuel tank.
- Do not remove fuel cap while engine is running.
- Do not refuel indoors where area is not well ventilated. Outdoor refueling is preferred.
- Do not refuel while engine is running. Allow engine to cool for 5 minutes before proceeding.
- Use fresh fuel. Stale fuel can gum carburetor and cause leakage.
- Check fuel lines and fittings frequently for cracks or leaks. Replace if necessary.
- Do not operate engine if fuel has spilled. Move machine away. Avoid creating any ignition until the fuel has evaporated.
- Do not run engine above rated speeds. This may result in damage and injury.
- Do not tamper with the engine speed selected by the original equipment manufacturer.
- Do not operate engine with grass, leaves, dirt or other combustible materials in muffler area.
- Do not operate engine without muffler.

- Do not tamper with governor springs, governor links or other parts which may increase the governed engine speed.
- Do not strike flywheel with hard object or metal tool. This may cause it to shatter in operation.
- Keep cylinder fins/governor parts free of grass and other debris which can affect engine speed.

WARNING

HOT EQUIPMENT HAZARD

Do not touch muffler, cylinder or fins while engine is running. Contact will cause burns.

- Do not use this engine on any forest covered, brush covered, or grass covered unimproved land, unless a spark arrester is installed on muffler. The arrester must be maintained in effective working order by operator.

In the State of California the above is required by law (Section 4442 of the California Public Resources Code). Other states may have similar laws. Federal laws apply on federal lands.

- Inspect the muffler periodically. Replace it when necessary.

If engine is equipped with a muffler deflector, inspect periodically. Replace with correct part.

- Do not check for spark, or crank engine with spark plug or spark plug wire removed.
- Do not run engine with air filter or its cover removed.

NOTICE

POSSIBLE ENGINE DAMAGE

Decelerate engine slowly to stop.
Avoid choking carburetor to stop engine.
Choke only for an emergency stop.

2.10 MAINTENANCE SAFETY

- Review Section 4: Service and Maintenance, before maintaining or operating the conveyor.
- Follow good shop practices:
 - Keep service area clean and dry.
 - Be sure electrical outlets and tools are properly grounded.
 - Use adequate light for the job.
- Place all controls in neutral or off. Stop engine, and remove ignition key. Wait for all moving parts to stop before servicing, adjusting, repairing.
- Relieve pressure from hydraulic circuit before servicing.
- Before applying pressure to a hydraulic system, make sure all components are tight and that hoses and couplings are in good condition.
- Keep hands, feet, hair and clothing away from all moving/rotating parts.
- Replace parts with genuine factory replacement parts to restore your equipment to original specifications.



Meridian Manufacturing Inc. will not be responsible for injuries or damages caused by use of unapproved parts and/or accessories.



- Make sure there is plenty of ventilation. Never operate the engine in a closed building. The exhaust fumes may cause asphyxiation.
- Clear the area of bystanders, especially children, when carrying out any maintenance and repairs or making any adjustments.
- Before resuming work, when maintenance work is complete, install and secure all guards.
- Replace damaged or not clearly visible decals.

2.11 TIRE SAFETY

- Failure to follow procedure when mounting a tire on a wheel or rim can produce an explosion and may result in serious injury or death.
- Do not attempt to mount a tire unless you have proper equipment and training to do the job.
- Have a qualified tire dealer or repair service perform required tire maintenance.
- When replacing worn tires, make sure they meet the original tire specifications. Never undersize.
- Reference the tire side wall for information on the maximum cold tire pressure (PSI). Keep the tires inflated to this specified amount.



2.12 BATTERY SAFETY

- Keep all sparks and flames away from batteries, as gas given off by electrolyte is explosive. 
- Avoid contact with battery electrolyte: wash off any spilled electrolyte immediately.
- Wear safety glasses when working near batteries. 
- Do not tip batteries more than 45 degrees, to avoid electrolyte loss.
- To avoid injury from spark or short circuit, disconnect battery ground cable before servicing any part of electrical system.
- Boosting the engine through the battery, or recharging the battery, will cause a short in the wireless system, killing it.

To boost the engine:

- Remove the fuse from the wireless receiver (remote control) box
- Boost the engine
- Reinstall the fuse

To recharge the battery:



- Disconnect the battery cables
- Recharge the battery
- Reconnect the cables



364600002





- Before using the battery, after it has been in storage, be sure it has the optimal charge.

2.13 HYDRAULIC SAFETY

- Always place all hydraulic controls in neutral before disconnecting and working on the hydraulic systems.
- Relieve pressure in hydraulic system before maintaining or working on machine.
- Be sure that all components in the hydraulic system are kept in good condition and are clean.
- Replace any worn, cut, abraded, flattened or crimped hoses.
- Do not attempt any makeshift repairs to the hydraulic fittings or hoses by using tape, clamps or cements. The hydraulic system operates under extremely high-pressure. Such repairs will fail suddenly and create a hazardous and unsafe condition.
- Wear proper hand and eye protection when searching for a high-pressure hydraulic leak. Use a piece of wood or cardboard as a backstop instead of hands to isolate and identify a leak. 
- If injured by a concentrated high-pressure stream of hydraulic fluid, seek medical attention immediately. Serious infection or toxic reaction can develop from hydraulic fluid piercing the skin surface. 

2.14 OPERATING SAFETY

- Please remember it is important that you read and heed the safety messages on the CST. Clean or replace all decals that cannot be clearly read and understood. They are there for your safety, as well as the safety of others.
- Ensure that everyone operating the CST, working on, or around it, reads and understands all the information in the operator's manual. 

Review the safety, operating and maintenance instructions annually.
- Keep all bystanders, especially children, away from the machine when loading or unloading. Only authorized personnel should be in the area when carrying out maintenance work.
- Do not place hands, arms or body near moving parts, to prevent pinching or crushing. Components can move unexpectedly. 
- Use care when climbing on frame or ladder to prevent slipping or falling. 
- Establish a lock-out, tag-out policy for the work site. Be sure all personnel are trained in and follow all procedures. Lock-out, tag-out all power sources before servicing the unit or working around loading/unloading equipment.
- Stop the engine. Place all controls in neutral, remove ignition key and wait for all moving parts to stop before servicing, adjusting, repairing or unplugging.
- Be familiar with machine hazard areas. If anyone enters these spaces, shut down machine immediately. Clear the area before restarting.
- Keep hands, feet, hair and clothing away from all moving and/or rotating parts. 
- Do not allow riders on the tender when transporting.
- Keep working area clean and free of debris to prevent slipping or tripping. 
- Stay away from overhead obstructions and power lines during operation and transporting. Electrocutation can occur without direct contact. 
- Do not operate machine when any guards are removed.
- Set park brake on tractor before starting.
- Be sure that the rear, fold conveyor is empty before raising/lowering, swinging or shuttling.
- The rear, fold conveyor is 22 feet long. It unfolds over the top, and can swing 144 degrees, side to side. Always give enough space for its operation

2.15 WORKPLACE HAZARD AREA

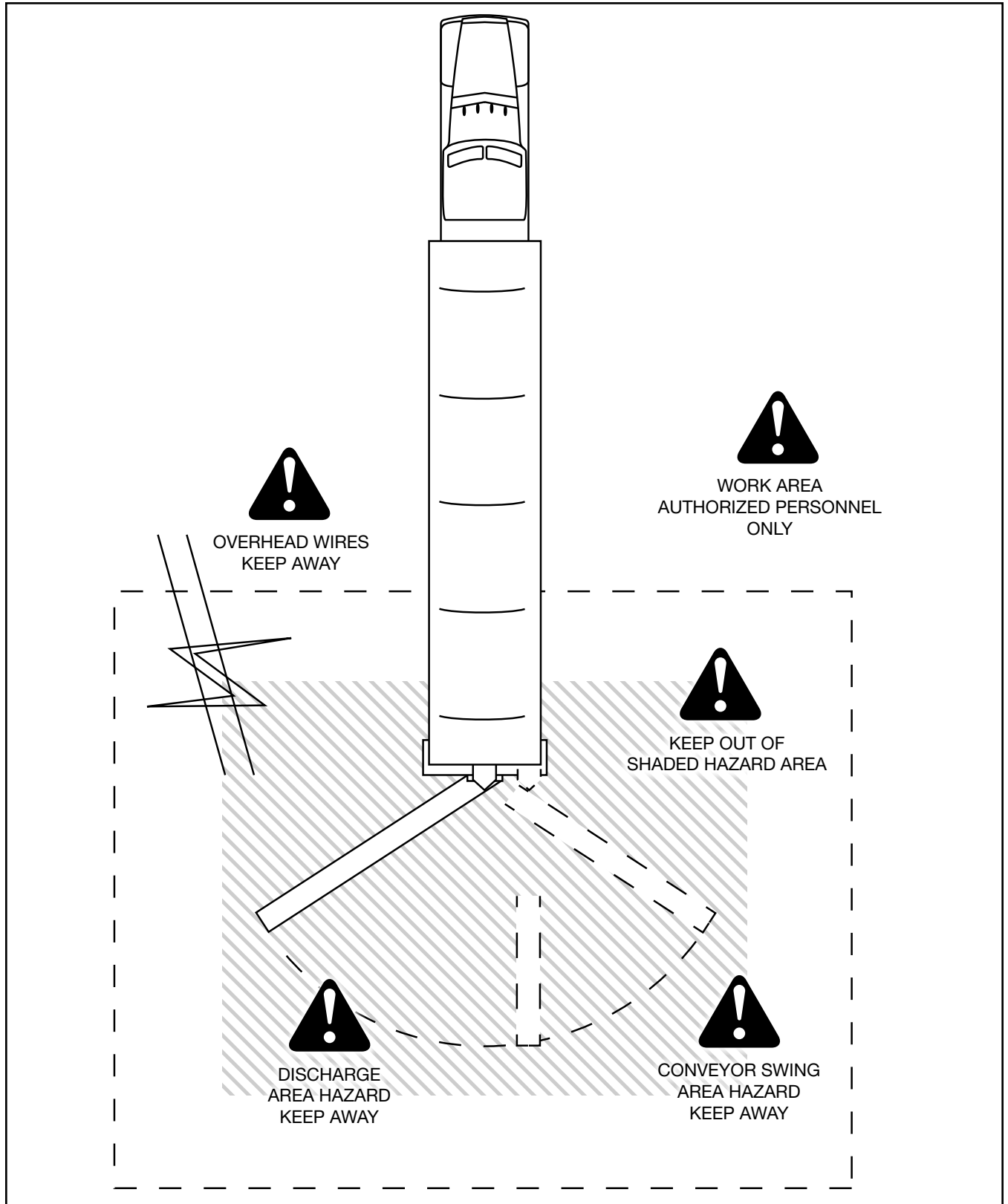



Fig 4 - Workplace Hazard Area

2.16 TRANSPORT SAFETY

- Close valves in hydraulic line before transporting.
- Check that all the lights, reflectors and other lighting requirements are installed and in good working condition.
- Be sure that the trailer is equipped with brakes that are in good working order. Be familiar with their operation.
- Never allow riders on the trailer.
- Comply with all local laws governing safety and transporting of equipment on public roads.
- Do not exceed a safe travel speed. Slow down for rough terrain and when cornering.
- Stay away from overhead power lines. Electrocutation can occur without direct contact. 
- Plan your route to avoid heavy traffic.
- Do not drink and drive.
- Be a safe and courteous driver. Always yield to oncoming traffic in all situations, including narrow bridges, intersections, etc. Watch for traffic when operating near or crossing roadways.

2.17 STORAGE SAFETY

- Store the CST on a firm, level surface.
- Store in an area away from human activity.
- If required, make sure the unit is solidly blocked up.
- Make certain all mechanical locks are safely and positively connected before storing.
- Remove the battery. Be sure it is fully charged. Store it inside. Do not sit the battery on a cold concrete floor.
- Do not permit children to play on or around the stored machine.

Section 3: OPERATION

WARNING

- Read and understand the Operator's Manual, and all safety decals, before using.
- Place all controls in neutral, stop the engine, remove ignition key. Wait for all moving parts to stop before servicing, adjusting, repairing or unplugging.
- Clear the area of bystanders, especially children, before starting.
- Install and secure all guards before starting. Do not operate machine when any guards are removed.
- Use care when climbing on frame or ladder to prevent slipping or falling.
- Stay away from overhead obstructions and power lines during operation. Electrocution can occur without direct contact.
- Do not allow riders on CST when transporting.
- Keep hands, feet, hair and clothing away from all moving and/or rotating parts.
- Do not place hands, arms or body between moving parts to prevent pinching or crushing. Components can move unexpectedly.
- Keep hydraulic components in good condition.
- Keep working area clean and free of debris to prevent slipping or tripping.
- Establish a lock-out, tag-out policy for the work site. Train all personnel in, and follow all procedures. Lock-out, tag-out all power sources before servicing the unit or working around loading/unloading equipment.

The Convey-All® Commercial Seed Tender has many features incorporated into it as a result of suggestions made by customers like you.

Hazard controls and accident prevention depend on the personnel operating and maintaining the equipment. Their concern, attentiveness and proper training are crucial.

It is the responsibility of the owner and operators to read this manual and to train all personnel before they start working with the machine. By following recommended procedure, a safe working environment is provided for the operator, co-workers and bystanders in the area around the work site.

By following these procedures, in conjunction with a good maintenance program, your tender will provide many years of trouble free service.

3.1 MACHINE COMPONENTS

The main components are listed below. Some options shown which may not be available on all models.

- * Positions may vary depending on the model.
- * Not all components are available on all tenders.

- a. Five Compartments
- b. Compartment gates (one below each gate)
- c. Slave conveyor
- d. Slave conveyor hydraulic drive
- e. Slave conveyor discharge spout
- f. Rear, fold conveyor
- g. Engine
- h. Fuel tank and battery
- i. Hydraulic oil reservoir (right-side of tender)
- j. Manual hydraulic valves
- k. Wireless receiver box
- l. Wireless remote control handset
- m. Weigh scale control panel (if equipped)
- n. Junction boxes (one per side)
- o. Scale cells (sandwiched between tender and trailer)
- p. Ladder
- q. Canvas tarp
- r. Tarp control
- s. Gate light box
- t. Document holder



Fig 5 - Wireless handset

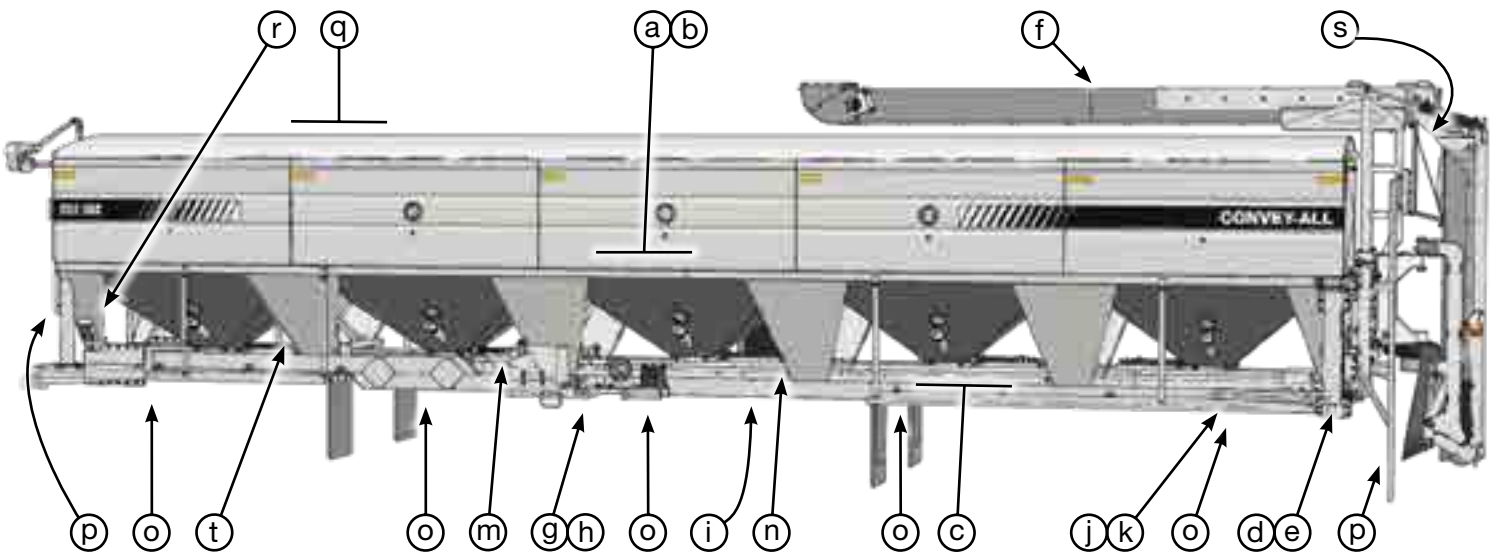

Fig 6 - Components of the CST-39C tender

3.2 COMPONENTS AND CONTROLS

Before starting to work, all operators must familiarize themselves with the location and function of the components and controls on the tender.

Gas Engine:

Read the engine manufacturer's manual, before starting, for more detailed instructions.

- a. **Battery Lock-Out Switch:**
Turn the switch clockwise to give battery power to entire CST.
- b. **Ignition Switch:**
Insert the key to operate.
- c. **Choke:**
Choke valve for starting when the engine is cold. Slide to the left to open the choke as the engine warms.

Always open choke fully when operating conveyor.
- d. **Throttle:**
Start at a low RPM and let the engine warm up. Then increase to full RPM.

IMPORTANT:

Always operate at full throttle to allow the hydraulics to operate at maximum performance.

Fuel Tank and Battery:

The fuel tank has a capacity of 57 Litres (15 US Gallons).

Hydraulic Oil Reservoir and Filter:

The oil reservoir has a capacity of 95 Litres (25 US Gallons)

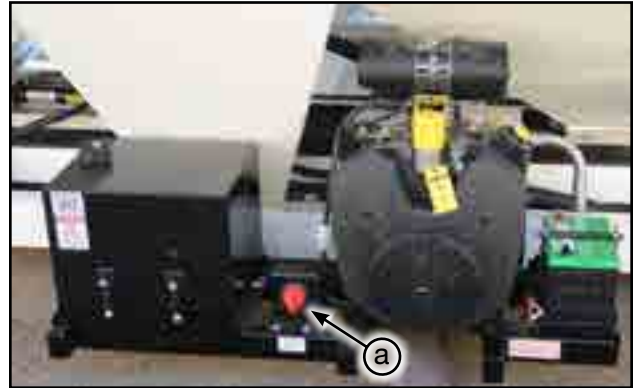

Fig 7 - Fuel tank, lock-out switch, and engine



Fig 8 - Engine controls



Fig 9 - Hydraulic oil reservoir and filter

Hydraulic Valve Bank:

The wireless handset will operate functions.

All tender functions can also be manually controlled at the bank of hydraulic valves mounted on the rear, left or right-side frame. Each valve is designed with a flow control as part of the base.

- a. Floater Valve is on the left-side of the main block behind the pressure gauge.
 - **Note:** This overrides the remote control.
 - Rotate the floater valve stem fully open (up) to activate the manual valve functions.
 - Close the valve stem to deactivate.
- b. Five Gate Valves:
 - Push down valve head to open the gate.
 - Pull up, to close the gate.
- c. Swing Conveyor:
 - Pull up the valve head to swing conveyor around to the left.
 - Push down, to swing it right.
- d. Fold Conveyor:
 - Pull up the valve head to unfold conveyor.
 - Push down, to fold the conveyor.
- e. Shuttle Conveyor:
 - Pull up the valve head to slide the conveyor right, horizontally along the rear frame.
 - Push down, to slide the conveyor left.
- f. Lift/Lower Conveyor Angle: (Raise/lower rear conveyor discharge):
 - Pull up the valve head to raise the discharge.
 - Push down, to lower it.

Note:

Slave and rear, fold conveyor motors are connected and run by the same valve.

Note:

The Floater Valve must be activated to manually operate the belt valves.

Note:

Belt valve heads may be a push/pull or threaded stem type.

- Pull up and rotate a half-turn to lock.
- or -
- Rotate the head fully open (up) or fully closed (down).

One of these actions will run the belts.

- g. Slave/Rear conveyor belt motors valve: Pull up (or rotate) to run both belts.
- h. Slave conveyor belt speed adjustment:
 - Pull up (or rotate), one of three valves, to run belt at that speed.
 - Front valve is speed 1
 - Middle valve is speed 2
 - Rear valve is speed 3
- i. Adjust the slave conveyor belt speed:
 - Rotate to loosen the lower dial.
 - Rotate the top dial; up to increase speed, down to decrease speed.
 - Tighten the lower dial when done.

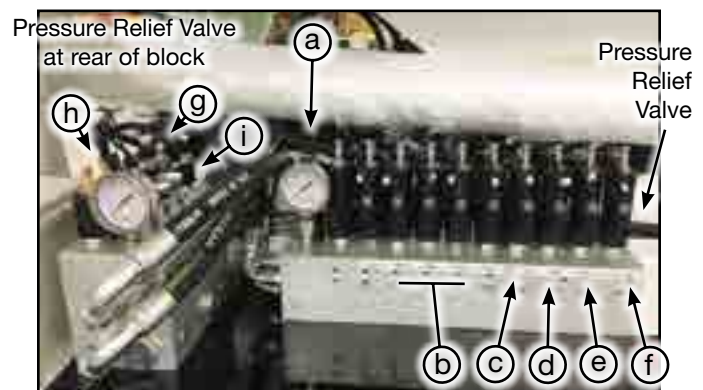

Fig 10 - Valve blocks

Wireless System:

The wireless functions correspond to the valve bank on the side, at the rear of the CST. The Wireless receiver box is mounted beside the hydraulic valve blocks.

Refer to the wireless system manual for specific setup and calibration instructions.

See Section 3.6 for general controls.



Fig 11 - Wireless receiver box

Slave Conveyor and its Discharge Spout:

The slave conveyor uses a PVC, smooth belt. It has a spout to discharge product directly, without using the rear, fold conveyor.

The slave conveyor belt speed can be adjusted using the manual valves. See page 3-4.



Fig 12 - Slave discharge spout

Rear, Fold Conveyor (Patented):

The tender uses 3 Limit Switches to control the rear, fold conveyor's movements:

- Rear Conveyor's swing must be centred before folding.
- Rear Conveyor must be fully folded on top of tender before shuttling sideways.
- Discharge portion (to the Fold Pivot) of the Rear Conveyor must be fully unfolded for the conveyor belt motors to run.

IMPORTANT:

The third limit switch will allow the conveyor motors to run when unfolded, pointing vertical. Always lower conveyor to run at 40° or less.

Capacity is drastically reduced when at steeper angle.



Fig 13 - Rear, fold conveyor

These are the measurements and movements of the rear, fold conveyor.

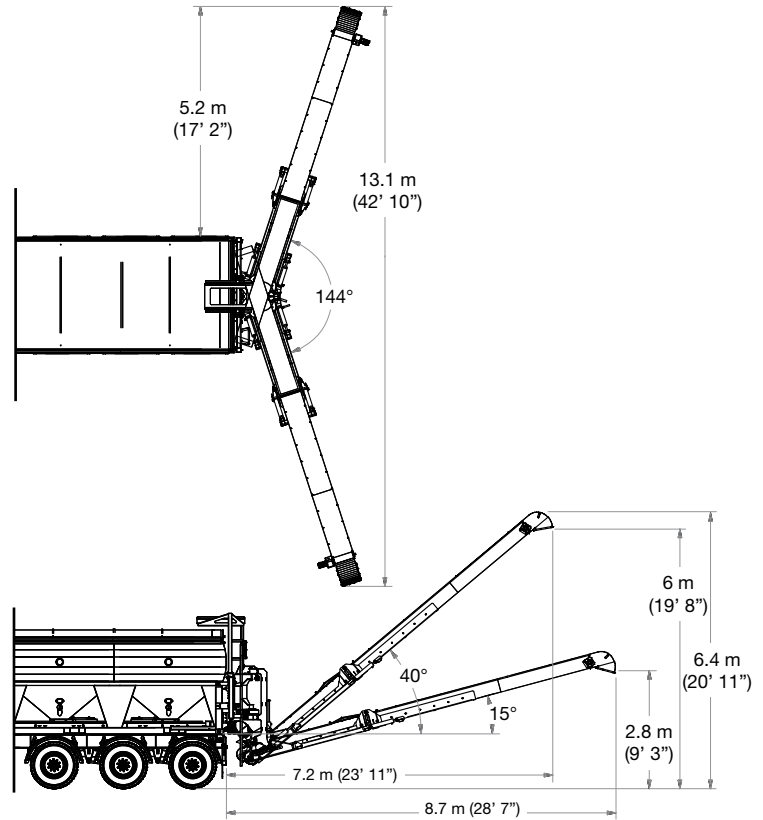

Fig 14 - Rear conveyor movements and measurements

Conveyor Belts:

The slave conveyor uses a smooth, PVC belt. The rear, fold conveyor has a paddle belt.



Fig 15 - Paddle belt on rear, fold conveyor

Gate Status Lights:

A panel of lights on the rear of the frame indicates the status of the gates on the bottom of the hoppers.

When the light is illuminated, the gate is open.

Be sure to press the button on the remote control until the light goes OFF and the gate is completely closed.

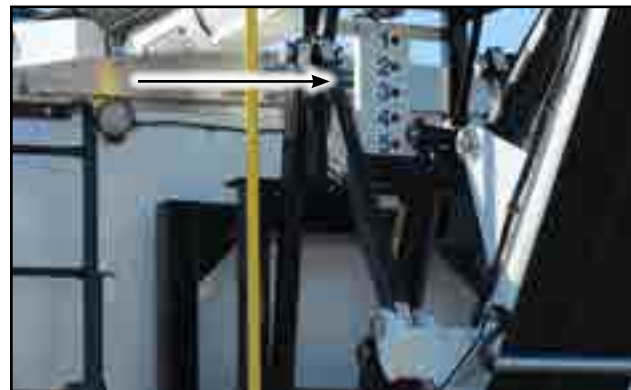

Fig 16 - Hopper gate status lights

NOTICE

COATING DAMAGE POSSIBLE
Always cover the tender with roll tarp when not in use to prevent compartment coating damage.

Electric Roll Tarp:

The control box for the electric motor is located at the front, corner.

- The tarp can also be operated with the remote control key fob.

Sight Glass:

Each hopper in the tender is designed with an upper and lower sight glass to allow the operator to monitor the amount of material in the hopper.

Poke-Hole Tube:

Each hopper has a poke-hole tube, on the left-side. This can be used to take samples or if bridging occurs.

Working Lights:

There are two lights mounted at the top, rear of the tender. Another light is situated at the end of the rear, fold conveyor discharge spout.

There are three smaller lights located:

- above the engine
- above the hydraulic valve blocks
- above the hydraulic oil reservoir

The lights are controlled from the remote control handset.



Fig 17 - Roll tarp and controls



Fig 18 - Sight glasses



Fig 19 - Poke-hole tube



Fig 20 - Camera and working light

Camera (Optional):

A camera can be mounted on the end of the rear, fold conveyor discharge spout.

The cables for the camera monitor screen may be strung to the front of the tender by the factory. From there, the owner can hook up the screen to the truck cab, or another location.



Fig 23 - Weight Scale Indicator

Weight Scale (Optional):

A weigh scale package may be available. It would be used to weigh all the compartments together.

- Load cells would be sandwiched between the tender frame and trailer.
- Two junction boxes, one per side, would connect the load cells on its side.
- The information collected by the load cells, is displayed on the control panel and wireless handset (if equipped).



Fig 24 - (a) Load Cell, (b) weigh scale junction box

Note:

Refer to the Scale Indicator and Wireless Handset user manuals for instructions on operation and calibration.

Compartment Ladder Rungs:

There are ladder rungs welded to the interior walls to provide access to the inside of each compartment.



Fig 21 - Compartment ladder rungs

Exterior Ladders:

There is a stationary ladder at the front. The rear ladder, is removable. It can be positioned on either side at the rear of the tender. See Section 3.7 for instructions.



Fig 22 - Front exterior ladder

Document Holder:

A document holder is secured to the front, left-side hopper support, above the fender.

3.3 MACHINE BREAK-IN

There are no operational restrictions on the tender when used for the first time.

The conveyor belt alignment is set at the factory, to track correctly without carrying a load.

Before Starting:

1. Read the engine, trailer and tender operator's manuals.
2. Review the Pre-Operation Inspection checklist before starting machine.

After Operating or Transporting for 1/2 hour:

3. Lubricate the points defined in Section 4: Service and Maintenance.
4. Check the conveyor hydraulic drive systems. Adjust as required.
5. Check both conveyor belts tension and alignment.
6. Check hardware and fasteners. Tighten to their specified torque.
7. Check the remote control handset. Be sure that it functions properly.
8. Check that the trailer brakes are functioning well.
9. Check engine and hydraulic fluid levels.

After 10 Hours:

Go to the service schedule as defined in the Section 4.2 Servicing Intervals.

3.4 PRE-TRIP INSPECTION

Efficient and safe operation of the tender requires that each operator knows the operating procedures.

It is important for both personal safety and maintaining the good mechanical condition of the machine that this checklist be followed.

The following areas should be checked before each trip, for personal safety and to maintain the good mechanical condition of your tender:

1. Inspect trailer/tender for damage or leaks.
2. Inspect suspension system and air brakes.
 - No air leaks. No wear on hoses and cables.
3. Lights and reflectors must be clean, undamaged and operational.
4. Check tire pressure, treads and sidewalls.
5. Tighten wheel hubs. Hub oil level is high.
6. Rear, fold conveyor must be in transport position, when not in use.
7. Check engine, fuel and hydraulic oil levels.
8. Be sure the battery has optimal charge. If needed, charge the battery before connecting it with the battery cables.
9. Lubricate the machine per the schedule outlined in the Maintenance section.

3.5 PRE-OPERATION INSPECTION

10. Check that the rear, fold conveyor can move freely.
11. Check that both conveyor belts are aligned and tensioned properly.
12. Remove any entangled material.

3.6 WIRELESS HANDSET FUNCTIONS

The wireless handset functions correspond to the manual valve on the tender. The following are explanations of each button and its function:

 **ON/OFF Button (Red):**
Turns the handset on and off.

 **LIGHTS Button:**
Turns CST's working lights on and off.

Weigh Scale Functions:

SETUP  **SETUP Button:**
Refer to wireless handset's manual for handset default settings and functions.

 **ZERO Button:**
Resets the scale, when no load applied.

 **GROSS / NET Button:**
- Press to view Gross weight for entire unit.
- Press again to show Net weight.

 **TARE Button:**
Press to enter weight of the empty tender.

Rear, Fold Conveyor Movements:

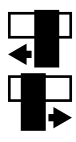
 **SHUTTLE Buttons:**
Shuttle the rear conveyor frame from centre (below slave conveyor discharge) to the left or right.

UNFOLD  **UNFOLD Button:**
Unfold the discharge section (to the Fold Pivot) to be in-line with the lower section.
• Unfold Completely!

FOLD  **FOLD Button:**
Fold the discharge section (to the Fold Pivot) to lay over top the tender.
• Fold Completely!

 **SWING Buttons:**
The rear conveyor can be swung 144°. It must be at "rotation centre" (point directly back) to fold.

 **RAISE/LOWER Buttons:**
The rear conveyor can be raised or lowered into working position.

Conveyor Belt Motor Operation:

 **BELT POWER Button:**
Turns both belt motors on and off.

 **BELT SPEED Button:**
There are three speeds, press button a fourth time to return to the first setting.

Compartment Gate Operation:

 **SELECT GATE Button:**
Press to choose a compartment gate. An LED on the back of the tender will identify the open gate.

 **OPEN GATE Button:**
Opens selected compartment gate.

 **CLOSE GATE Button:**
Closes selected compartment gate.



Fig 25 - Remote control handset

3.7 REAR CONVEYOR SHUTTLE MOVEMENT

NOTICE

BALANCE HAZARD

It is possible to transport the tender with the rear conveyor shuttled to the side. Be aware of the off-centre weight.

From the factory, the shuttle movement on the rear, fold conveyor is set to be from centre to the right.

- Push the hydraulic valve in, moves the conveyor from centre to the right side.
- Pull valve up, moves conveyor left, back to centre.

Note:

Push valve IN retracts cylinder
Pull valve OUT extends cylinder

The movement can be changed to shuttle from centre to the left side.

1. Centre conveyor.
2. Remove the bolt and pin holding the extended cylinder to the conveyor frame.
3. Use the hydraulics to retract the cylinder only. It is free from the conveyor, leaving it centred.
4. When retracted, install the pin, and bolt into place on the right side of the conveyor.



Fig 26 - Rear, fold conveyor shuttle movement



Fig 27 - Cylinder frame connection



Fig 28 - Alternate cylinder frame connection

5. The rear ladder will need to be moved from the left to right side.
 - Remove the 2 hair pins (a).
 - Lift ladder, and remove it from the frame (b).
6. Place the ladder on the right side, and secure with the hair pins.

The rear conveyor will now shuttle to the left side.

Note:

The hydraulic valve will now move the conveyor opposite from before.

Push valve IN retracts cylinder, centring conveyor.

Pull valve OUT extends cylinder, shuttles to the left.

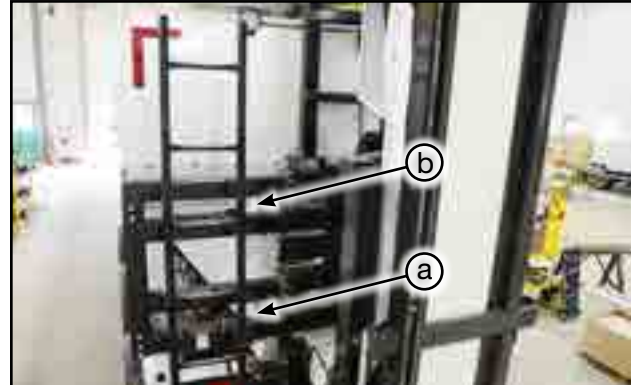

Fig 29 - Rear ladder

3.8 OPERATING ON SITE

The Convey-All® CST is designed to handle any kind of seed, granular or chemical. Use the unit to transport it to or from the field as required. The tender can also be used to transport product to market.

Inspect the machine at the start of each day to be sure it is in good mechanical condition.

1. Perform Pre-Trip and Pre-Operation Inspections. Refer to Section 3.4 and 3.5
2. Attach the CST trailer to the towing truck.
3. Transport to the working location.
4. Set truck park brake and remove ignition key.
5. Disengage Battery Lock-Out Switch, to give battery power to the tarp controls.
6. Open roll top cover.
7. Fill the hopper(s).
8. Close the roll-top cover.
9. Engage the Battery Lock-Out Switch.
10. Transport to the unloading area.



Fig 30 - Roll tarp cover



Fig 31 - Roll tarp controls



Fig 32 - Filling the hopper



Fig 33 - Transporting CST to site

⚠ WARNING

STRANGULATION HAZARD

Careful the wireless handset does not become caught in running machinery, while hanging from the neck.

11. Disengage the Battery Lock-Out Switch.
12. Start engine.

Note:

Refer to page 3-4 for hydraulic valves.
Refer to Section 3.6 for remote control wireless instructions.

⚠ DANGER

ELECTROCUTION HAZARD

Ensure enough clearance from overhead obstructions, power lines or other equipment.

13. Unfold the rear conveyor.

IMPORTANT:

Always run the conveyor at 40° or less.
Capacity will be drastically reduced at steeper angle.

14. Move the conveyor into position.
 - The rear conveyor can be swung through a 144° arc to allow it to fill more than one compartment on the planter, drill, distributor or spreader.

Note:

Rear conveyor can be shuttled to the side, if not needed.



Fig 34 - Engine



Fig 35 - Rear conveyor

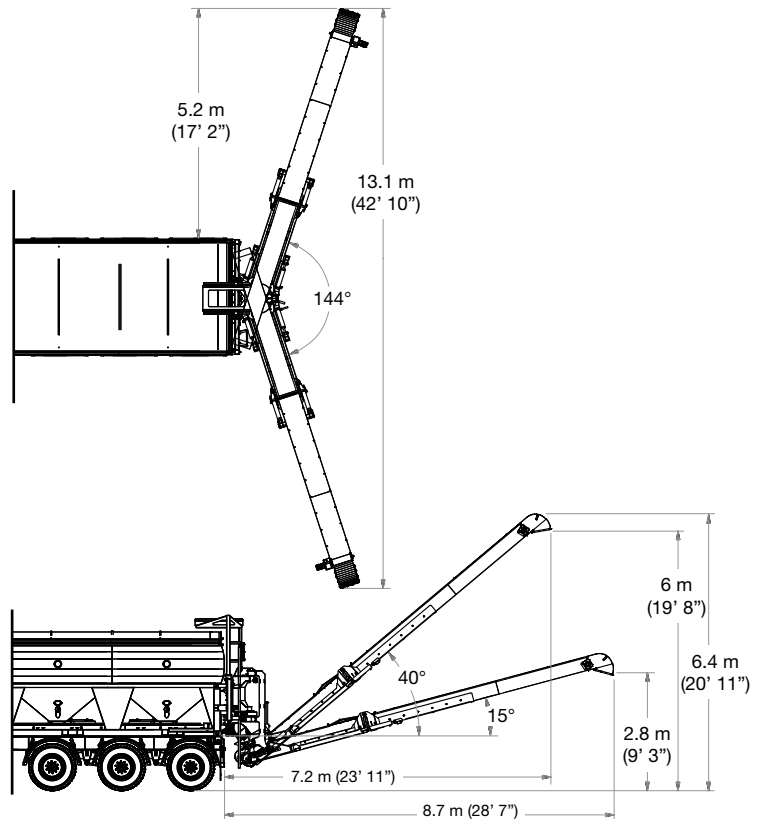

Fig 36 - Rear conveyor movements and measurements

15. Start the conveyor belt(s).

Note:

Both slave and rear conveyor are controlled with one valve. They have preset speed differences to prevent plugging.

16. Select a compartment to unload from.

17. Open the gate under the selected compartment to empty.



Fig 37 - Remote control



Fig 38 - Compartment discharge gate cylinder

NOTICE

PLUGGING HAZARD

Open one hopper at a time to minimize the chance of plugging the unit.



Fig 39 - Tender in field

18. Close the gate to the empty compartment, before opening the next one.



Fig 40 - Filling railcar

19. Be sure to close all compartment gates when finished.

20. Turn off the conveyor belts.



Fig 41 - Hydraulic valve bank

21. Fold the rear conveyor completely, to lie flat on top of the tender.



Fig 42 - Rear, fold conveyor

22. Reduce engine speed to low idle.

23. Turn the engine OFF.
- Remove the ignition key.

24. Engage the Battery Lock-Out Switch.

25. Place remote control in a secure location for storage.



Fig 43 - Gas engine

Continue on with your work day.

3.9 STORAGE

After the season's use, or when the CST will not be used for an extended period of time, it should be thoroughly inspect and prepared for storage.

Repair or replace any worn or damaged components to prevent unnecessary down-time next season.

For a long, trouble-free life, this procedure should be followed when preparing the machine for storage:

1. Remove all left over product or residue from inside the compartments, and around both conveyor belts.
2. Inspect all moving or rotating parts and remove anything which has become entangled.
3. Wash the entire machine thoroughly to remove all dirt, mud, debris and residue.
 - Wash the outside.
 - Wash inside the compartments and around the gates.
 - Wash the top and under the belts.
 - Clean inside the rear conveyor tube.
4. Close roll tarp to prevent unauthorized entry into the compartments. Also to protect the compartment coating against sun damage.
5. Inspect all hydraulic hoses, fittings, lines, couplers and valves.
 - Tighten any loose fittings.
 - Replace any hose that is badly cut, nicked or abraded or is separating from the crimped end of the fitting.
6. Lubricate all grease fittings.
 - Ensure all grease cavities have been filled with grease to remove any water residue from having been washed.
7. Check the condition of the slave and rear conveyor belts. Replace if necessary.
8. Remove the battery.
 - Be sure it is fully charged.
 - Store it inside.
 - Do not sit battery on a cold, concrete floor.
9. Touch up all paint nicks and scratches to prevent rusting.
10. Select an area that is dry, level and free of debris.
 - If the tender cannot be placed inside, cover the engine with a waterproof tarpaulin and tie securely in place.
11. Remove the engine ignition key.
 - Store in a memorable location.
12. Do not allow children to climb on or play around the stored tender.

3.10 REMOVING FROM STORAGE

- If the tender has been stored for over six months, run the engine for 2-3 minutes. Then change the oil while still warm, to remove any condensation.
- Follow the Pre-Trip and Pre-Operation Inspection checklists in Sections 3.4 and 3.5.



Fig 44 - CST in storage

This page intentionally left blank

Section 4: SERVICE AND MAINTENANCE

WARNING

- Review the Operator's Manual and all safety items before maintaining the tender.
- Clear the area of bystanders, especially children, before repairing or adjusting.
- Before servicing, repairing or unplugging; place controls in neutral, stop engine, remove ignition key and wait for all moving parts to stop.
- Follow good shop practices:
 - Keep service area clean and dry.
 - Be sure electrical outlets and tools are properly grounded.
 - Use adequate light for the job at hand.
- Relieve pressure from hydraulic circuits before servicing or repairing.
- Before applying pressure to the hydraulic system, make sure all components are tight and all hoses/coupling are in good condition.
- Keep hands, feet, hair and clothing away from moving and/or rotating parts.
- Make sure there is plenty of ventilation. Never operate the engine in a closed building. The exhaust fumes may cause asphyxiation.
- Tighten all bolts, nuts and screws and check that all cotter pins are properly installed to ensure unit is in a safe condition.
- When maintenance is complete, before resuming work, install and secure all guards.
- Keep decals clean, replace if not readable.

By following the operating instructions, in conjunction with a good service and maintenance program, your tender will provide many years of trouble free service.

4.1 FLUIDS AND LUBRICANTS

Fuel & Engine Oil:

Refer to the engine operator's manual, for specific instructions.

- Fuel tank capacity is 57 Litres (15 US Gal).

Grease:

Use an SAE multipurpose high temperature grease with extreme pressure (EP) performance. Also acceptable, SAE multipurpose lithium based grease.

Hydraulic Oil:

Use an ISO grade 32 hydraulic oil for all operating conditions (Hydrex MV32 or comparable).

- Oil reservoir capacity is 95 Litres (25 US Gal).



3622000003

Storing Lubricants:

Your machine can operate at top efficiency only if clean lubricants are used. Use clean containers to handle all lubricants.

Store them in an area protected from dust, moisture and other contaminants.

4.1.1 Greasing:**NOTICE****GREASING HAZARD**

Too much grease causes excessive overheating. Under-greasing accelerates equipment wear.

No grease should be seen around bearings. If there is, too much grease was applied and the seal has ruptured!

IMPORTANT:

Grease bearings only one pump per month under normal usage conditions.

Bearing greasing frequency should be determined by usage and conditions.

1. Use a hand-held grease gun for all greasing.
2. Wipe grease fitting with a clean cloth before greasing, to avoid injecting dirt and grit.
3. All bearings are greasable, but require only minimal grease.

Recommended greasing is one small stroke every month. Be careful not to over-grease as this may push the seal out.

4. Replace/repair broken fittings immediately.
5. If fittings will not take grease, remove and clean thoroughly. Also clean lubricant passageway. Replace fitting if necessary.



1300006014

Fig 45 - Lubricate decal



Fig 46 - Gas engine



Fig 47 - Hydraulic oil reservoir

4.2 SERVICING INTERVALS

Use the Service Record provided on page 4-11, to keep a record of all scheduled maintenance.

The conveyor belt alignment is preset to run true under a condition of no load. It is important to check alignment and make adjustments, if required, during the initial few minutes of loaded operation.

Check bearings for wear daily.

The following recommended periods are based on normal operating conditions. Severe or unusual conditions may require more frequent lubrication and servicing.

IMPORTANT:

For engine servicing and maintenance, refer to it's manual for complete details.

4.2.1 Every 10 Hours or Daily:

1. Check fuel level.
 - Add as required.
2. Check oil level in hydraulic reservoir.
 - Add as required.
3. Inspect conveyor belt lacing for wear.
4. Check both conveyor belts tension daily while breaking-in the tender.
 - Refer to Section 4.3.1
5. Check both conveyor belts alignment frequently during the first 10 hours of operation until it seats itself.
 - Refer to Section 4.3.2
6. Inspect all rollers and bearings for play and wear.
 - Replace if necessary.



Fig 48 - Slave conveyor belt lacing



Fig 49 - Rear conveyor belt lacing

4.2.2 Every 50 Hours or Weekly:

7. Check both conveyor belt tensions.

Watch the tension more often while breaking-in the conveyor, because the belt may stretch. Refer to Section 4.3.1

Note:

A properly tensioned belt will not slip when in operation.

8. Check both conveyor belts alignment.
- How the belt is tracking on the rollers must be checked at both ends of the conveyors.

Watch the alignment more frequently during the first 10 hours of operation. It usually seats itself and can be checked weekly after that. Refer to Section 4.3.2

9. Inspect the hydraulic couplers for wear.



Fig 50 - Drive of slave conveyor



Fig 51 - Gate cylinder



Fig 52 - Tension bolts, slave conveyor



Fig 53 - Tension bolts on rear, fold conveyor

4.2.3 Every 100 Hours or Monthly:**Note:**

Recommended greasing is one small stroke every month. Be careful not to over grease as this may push the seal out.

10. Grease the slave conveyor roller bearings.
 - Tail end
 - Drive and discharge rollers
11. Grease the rear conveyor roller bearings (c).
 - Tail end
 - Rollers at the fold
 - Drive and discharge rollers
12. Grease rear conveyor movement points.
 - Fold points (d)
 - Swing points (e)
 - Shuttle points (f)
13. Grease the gate cylinder and bushings, below each compartment.

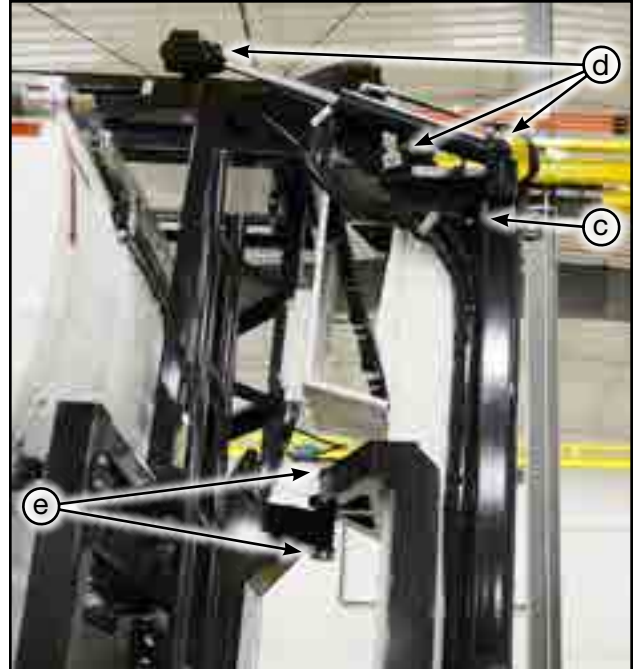

Fig 54 - Left-side of rear conveyor



Fig 55 - Rear conveyor discharge

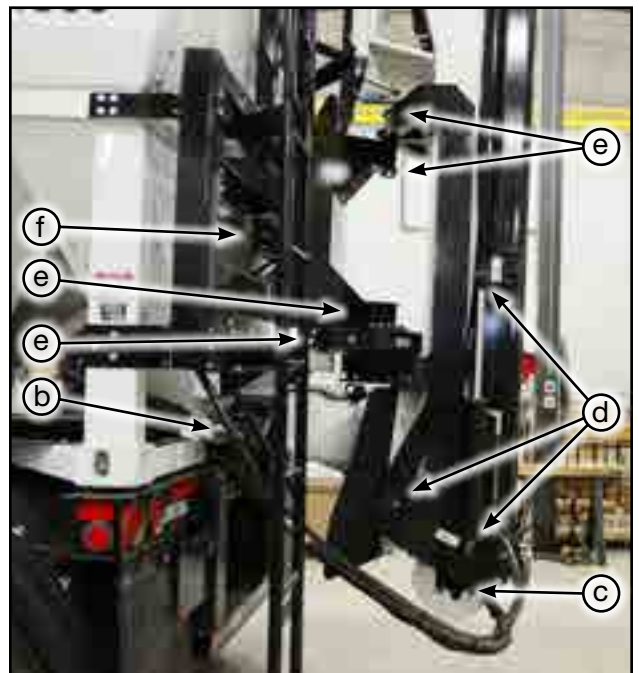

Fig 56 - Left-side of rear conveyor

4.2.4 Every 200 Hours or Annually:**IMPORTANT:**

Refer to engine manual for complete details on service and maintenance.

14. Take hydraulic oil sample and send to lab for particle count analysis.
 - Change oil if necessary.
15. Change hydraulic filter. Refer to Section 4.3.4
16. Check that the battery retains its maximum charge.
17. Ensure reflectors and work lights are clean and operational.
18. Wash the entire machine thoroughly to remove all dirt, mud, debris and residue.
 - Wash the outside.
 - Wash inside the compartments and around the gates.
 - Wash the top and under the belts, while they are running.
 - Clean inside the rear conveyor tube.
19. Maintain the tender's trailer to keep it in good condition. Refer to it's documentation.
 - Check the suspension and brakes.
 - Check the axle.
 - Inspect the tires and check the pressure.
 - Ensure the reflectors and transport lights are clean and operational.



Fig 57 - Hydraulic system and filter



Fig 58 - CST in storage

4.3 MAINTENANCE PROCEDURES

⚠ WARNING

ROTATING BELT HAZARD

Turn off engine, lock-out power and wait for all components to stop moving before adjusting the belt.

To check belt position, idle the engine, then rotate the belt slowly.

4.3.1 Conveyor Belts Tension:

The tension of both the slave and rear conveyor belts should be checked daily to insure proper function.

Note:

Belt is tensioned correctly when it does not slip on the drive roller when loaded.

Belt Tension of Slave Conveyor:

1. Loosen the roller bearing housings at the tail.
2. The tension is set and controlled by the springs on both sides of the slave conveyor belt.
3. Tighten, or loosen the tension bolts, so the springs measure 95mm (3-3/4 inches).
4. Tighten the roller bearing housing.
5. Measure the spring. Lengths must be equal.

Belt Tension of Rear, Fold Conveyor:

6. Loosen the roller bearing housings.
7. The tension is set and controlled by the springs on both sides of the rear conveyor.

Tighten, or loosen the tension bolts, so the springs measure 267mm (10-1/2 inches).

IMPORTANT:

Spring measurements are a starting point only.

8. After measuring the springs, continue to adjust, depending on the weight of the product.
 - For example: tighten more for fertilizer, loosen for lighter seed.
9. Tighten roller bearing housing.
10. Repeat with other side to maintain belt alignment.
11. Measure the spring lengths on both to be sure they are equal.



Fig 59 - Slave conveyor tension bolt and springs



Fig 60 - Tension bolts on rear conveyor

4.3.2 Conveyor Belts Alignment:

The belt is properly aligned when the it runs in the centre of the frame and the roller shafts.

Be sure to run the conveyor a full revolution to check the entire belt.

The belt can move from side-to-side while it is turning as long as it does not contact the sides. If it touches the sides, it must be aligned.

⚠ WARNING**ROTATING PART HAZARD**

Turn off engine. Wait for belt and rollers to stop moving, before working on the belt.

Note:

If belt is out of alignment, it will move to the loose side. Tighten loose side or loosen tight side.

Belt Adjustment of Slave Conveyor:

1. Loosen the roller bearing housing on the side to be adjusted.
2. Adjust by loosening or tightening the shaft bearing assemblies at the tail and discharge rollers.
 - Work on either the drive, or driven shaft end of the drive roller.
3. Tighten all the roller bearing housings.
4. Test the belt by running the conveyor belt.
5. Repeat this process until the belt tracks correctly.

Belt Adjustment of Rear, Fold Conveyor:

6. Loosen or tighten the shaft bearing assemblies at the tail and discharge rollers.
 - Work on either the drive, or driven shaft end of the drive roller.
7. Tighten all the roller bearing housings.
8. Test the belt by running the conveyor belt.
9. Repeat this process until the belt tracks correctly.



Fig 61 - Tension bolt on slave conveyor



Fig 62 - Tension bolts on rear conveyor

4.3.3 Conveyor Belt Replacement:

After replacing the belt, check the tension and alignment frequently during the first 10 hours of operation. Adjust as required. Then, go to the regular service schedule.

Normally a conveyor belt will seat itself during the first 10 hours of operation and then require less or no adjustment.

Slave Conveyor Belt Replacement:

1. Remove the discharge hood from slave conveyor.
2. Rotate the belt until the lacing is accessible at the discharge.
3. Loosen the belt tension.
4. Disconnect the conveyor belt by removing the lacing cable.
5. Attach the new belt to the end of the existing belt.
6. Pull the old belt out of the machine.
 - The new one will thread into position.
7. Disconnect the old belt and connect the ends of the new one together.
 - Cut off excess cable.
 - Crimp lacing at one end to lock cable in place.
 - Cut and taper the corners of the trailing end of the belt.

IMPORTANT:

Taper the trailing belt corners, so they doesn't catch when rotating.

8. Tension and align the new conveyor belt.
 - Refer to Sections 4.3.1 and 4.3.2

Rear (Incline) Conveyor Belt Replacement:

9. Open the access door at the bottom of the rear conveyor.
10. Rotate the belt until the lacing is accessible.
 - Loosen the belt tension.
11. Disconnect the conveyor belt by removing the lacing cable.
12. Attach the new belt to the end of the existing.
 - Pull the old belt out of the machine.
 - The new one will thread into position.
13. Disconnect the old belt and connect the ends of the new one together.
 - Cut excess cable.
 - Crimp lacing at one end to lock cable in place.
 - Cut and taper the corners of the trailing end of the belt.
14. Tension and align the new conveyor belt.



Fig 63 - Slave conveyor belt lacing



Fig 64 - Access door to paddle belt on rear conveyor

4.3.4 Change Hydraulic Oil:

Use an ISO grade 32 hydraulic oil for all operating conditions (Hydrex MV32 or comparable).

- Oil reservoir capacity is 95 Litres (25 US Gal)

⚠ WARNING

HOT LIQUID HAZARD

Allow hydraulics to cool before changing oil.
Hot oil will burn if it contacts exposed skin.

IMPORTANT:

Annually, have an oil sample tested for particle count.

Change oil only if necessary.

1. Allow the hydraulics to cool slightly before changing oil.

Note:

It is best to change oil while the engine is warm (not hot) to keep contaminants in suspension.

2. Place a large pan or pail under the drain plug.
- Container larger than 95 Litre (25 US Gal).
3. Remove drain plug and allow to drain for ten minutes.
4. Install and tighten the drain plug.
5. Dispose of the used oil in an approved container and manner.
6. Fill the reservoir with specified oil.

4.3.5 Change Hydraulic Filter:

1. Place pan under the filter to catch any spilled oil.
2. Remove hydraulic oil filter, and dispose of it.
3. Fill the new filter with hydraulic oil.
4. Apply a light coat of oil to the O-ring and install the replacement filter. Snug up by hand and then tighten another 1/2 turn.
5. Run engine and hydraulic for 1-2 minutes. Check for oil leaks.
6. If a leak is found around the drain plug or filter, tighten slightly.
7. Check oil level. Top up as required.



Fig 65 - Hydraulic oil reservoir and filter

4.4 SERVICE RECORD

See Section 4.2 for Servicing Intervals. That section is only a general guide under good conditions. Under extreme, or unusual circumstances adjust service timing accordingly.

For more detailed schedule pertaining to the specific engine model, consult its manual.

Copy this page to continue record.

Maintenance	Hours																		
	Serviced By																		
10 Hours or Daily																			
Check Fuel Level																			
Check Hydraulic Oil Level																			
Inspect Lacing on Conveyor Belts																			
Inspect All Rollers and Bearings																			
50 Hours or Weekly																			
Check Tension of Conveyor Belts																			
Check Alignment of Conveyor Belts																			
Inspect Hydraulic Drive Couplers/Chains																			
100 Hours or Monthly																			
Grease Slave Conveyor Roller Bearings																			
Grease Rear Conveyor Roller Bearings																			
Grease Rear Conveyor Movement Points																			
Grease Gate Cylinders and Bushings																			
200 Hours or Annually																			
Test Hydraulic Oil Sample																			
Change Hydraulic Filter and Oil																			
Check and Clean Reflectors, Lights																			
Wash Tender																			
Maintain Trailer																			

This page intentionally left blank

Section 5: TROUBLESHOOTING

This section contains a list of common problems, causes and offer quick solutions to those issues.

If problems are confronted which are difficult to solve, even after having read through this section, please contact your authorized dealer, distributor or Meridian Manufacturing Inc. Before you call, please have this Operator's Manual and the unit's serial number ready.

Problem

Possible Cause	Possible Solution
-----------------------	--------------------------

Engine Labouring

Belt is sticky on the back side, because of oily product or wet/snowy conditions	Clean the belt
Hopper flashing too tight	Adjust to loosen the flashing
Air cleaner dirty	Clean the air cleaner, and/or replace the air filter

Belt Not Turning

Hopper flashing may be stuck to belt, because it is running dry and rubber is heating up	Turn off unit! Manually peel flashing up and off hopper. Then run dry product through to create barrier between flashing and belt
--	---

Belt Doesn't Track Correctly

Roller lagging may be worn	Replace roller or have it relagged
----------------------------	------------------------------------

Product Leakage

Product may be getting under the belt at the hopper, traveling up inside the belt and leaking off delivery end	Replace hopper flashing
--	-------------------------

Conveyor Won't Run

No power	Start engine, increase speed to maximum RPM
----------	---

continued on next page

Problem

Possible Cause	Possible Solution
-----------------------	--------------------------

Low Capacity

Drive roller worn out or is slipping	Replace drive belt
Hydraulic system - valve, pump or motor could be malfunctioning	Check and adjust pressure set screw on valve. Test flow from pump. Check for oil leaks under motor. Replace what is needed.

Remote Control Not Functioning

Batteries may have died during storage	Ensure batteries are good
Batteries replaced, but still won't work	Need to synchronize Remote Control to Receiver

Charging Battery Will Short Remote Control Electrical System

Boosting current will short electrical system	If boosting to start engine, remove fuse from receiver box. If recharging battery, disconnect from CST
---	--

No Hydraulic Flow

Flow valve closed	Open flow circuit valve
Hydraulic filter plugged	Replace plugged hydraulic filter

Section 6: REFERENCE

For information not included here, or for a digital copy of this manual, please call your dealer, or Meridian Manufacturing Inc. directly for assistance: (800) 665-7259.

Specifications and measurements are subject to change without notice.

Table 1 - Specifications

MODEL	LENGTH	TOTAL BUSHELS (CUBIC FEET)	TOTAL TONNES (TONS*)	NUMBER - SIZE OF COMPARTMENTS	BUSHELS PER COMPARTMENT	TONNES PER COMPARTMENT	REAR CONVEYOR LENGTH	DISCHARGE HEIGHT	BODY WIDTH	OVERALL HEIGHT W/ TRAILER	FULL CONVEYOR SWING
CST-39-C	13.4 m (43' 11")	1080 (1350)	36.8 (40.5)	5 - 2.38 m	216	7.36	8.2 m (27')	2.8 - 6 m (9' 3"-19' 8")	2.6 m (8' 6")	4.1 m (13' 5")	13.1 m (42' 10")

* Units based on 50 lb/unit. ** Capacity based on 62 lb/ft³.

Table is base on liquid measurements, and does not account for piling above the side walls

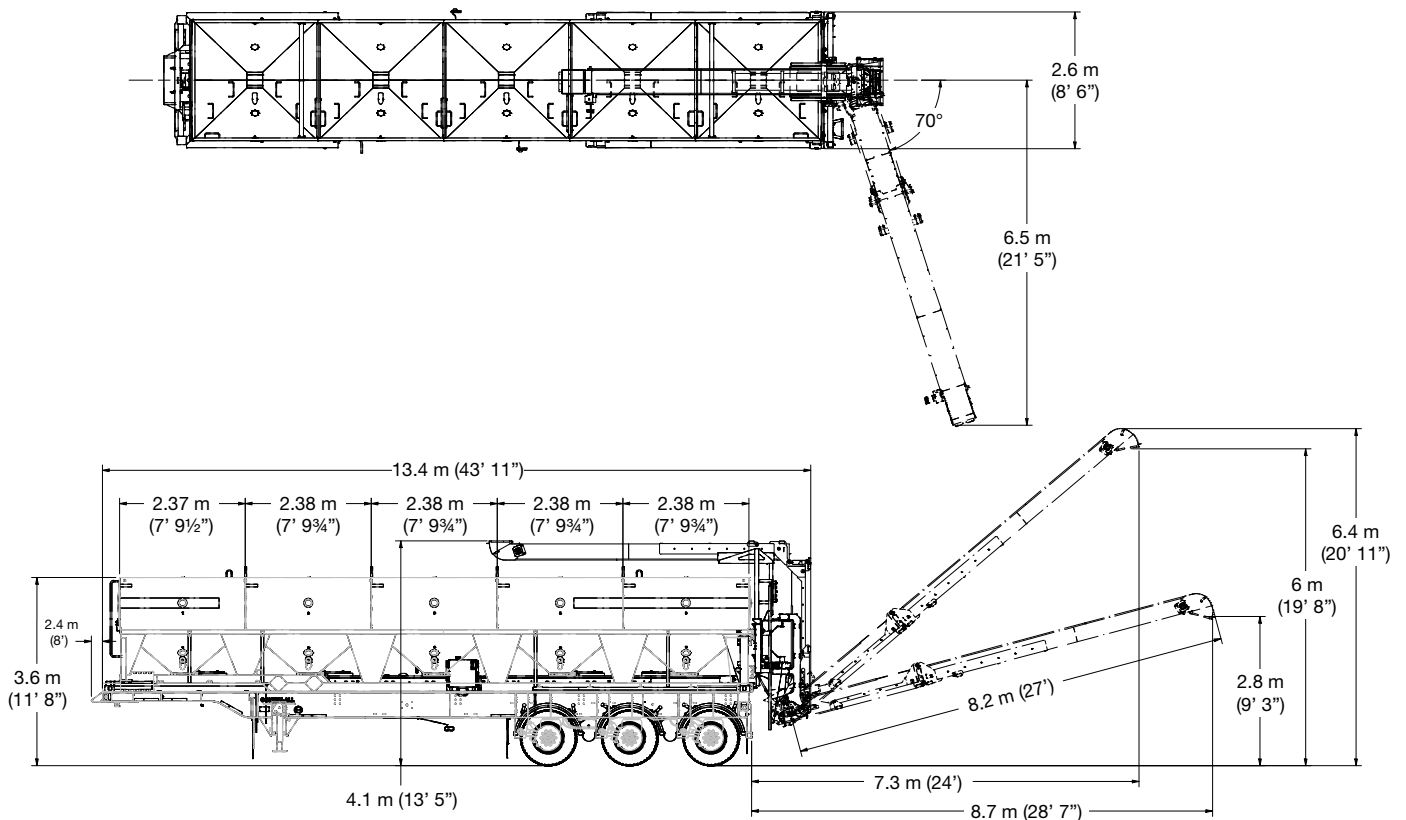

6.1 BOLT TORQUE

The tables shown below give correct torque values for various bolts and capscrews. Tighten all bolts to the torques specified in chart unless otherwise noted. Check tightness of bolts periodically, using bolt torque chart as a guide. Replace hardware with the same strength bolt.

Table 2 - English Torque Specifications

BOLT DIA. "A"	BOLT TORQUE*					
	SAE 2 (NM) (FT-LB)		SAE 5 (NM) (FT-LB)		SAE 8 (NM) (FT-LB)	
1/4"	8	6	12	9	17	12
5/16"	13	10	25	19	36	27
3/8"	27	20	45	33	63	45
7/16"	41	30	72	53	100	75
1/2"	61	45	110	80	155	115
9/16"	95	60	155	115	220	165
5/8"	128	95	215	160	305	220
3/4"	225	165	390	290	540	400
7/8"	230	170	570	420	880	650
1"	345	225	850	630	1320	970

Table 3 - Metric Torque Specifications

BOLT DIA. "A"	BOLT TORQUE*			
	8.8 (NM) (FT-LB)		10.9 (NM) (FT-LB)	
M3	0.5	0.4	1.8	1.3
M4	3	2.2	4.5	3.3
M5	6	4	9	7
M6	10	7	15	11
M8	25	18	35	26
M10	50	37	70	52
M12	90	66	125	92
M14	140	103	200	148
M16	225	166	310	229
M20	435	321	610	450
M24	750	553	1050	774
M30	1495	1103	2100	1550
M36	2600	1917	3675	2710

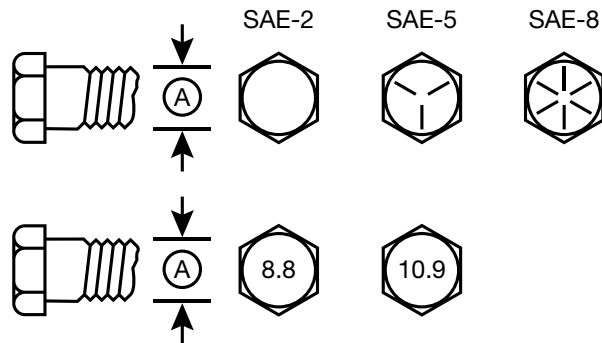

Torque figures indicated above are valid for non-greased or non-oiled threads and heads unless otherwise specified. Therefore, do not grease or oil bolts or capscrews unless otherwise specified in this manual. When using locking elements, increase torque values by 5%.

* Torque value for bolts and capscrews are identified by their head markings.

This page intentionally left blank

LIMITED WARRANTY STATEMENT

1. Meridian Manufacturing Inc, hereafter referred to as Meridian®, warrants each new product (the "Goods") to be free from defects in material and workmanship under normal use and service for a period of one (1) year or ninety (90) days in the case of commercial use, from the shipment date from the Meridian dealer (FCA).
2. Meridian warrants replacement parts and components either manufactured or sold by, will be free from defects in materials or workmanship under normal use and service for thirty (30) days from the shipment date from the Meridian dealer (FCA), or the remainder of the original warranty period on the Goods, whichever is longer.
3. This warranty does not apply to:
 - a. To any merchandise or components thereof, which in the sole and unfettered opinion of Meridian, have been subject to misuse, unauthorized modifications, alteration, accident, negligence, product abuse or lack of required maintenance.
 - b. If repairs have been made with parts or by persons other than those parts or persons approved by Meridian.
 - c. To parts and accessories not manufactured by Meridian including, but not limited to, engines, batteries, tires, belts, PTO shafts or other trade accessories. Such parts shall be covered by the warranty given by the actual manufacturer, if any.
 - d. To failure of parts; or failure of parts to perform due to wear under normal or excessive service conditions; or to failure due to use by the Purchaser for purposes other than originally intended at time of manufacture, including without limitation using the Goods for mixing fertilizer, etc.; or used in excess of the built specifications.
 - e. To Goods used in areas exposed to corrosive or aggressive conditions including, but not limited to, salt water from either inside or outside the Goods.
 - f. To failures or defects arising out of damage during shipment or during storage.
 - g. To materials replaced or repaired under this warranty, except to the extent of the remainder of the applicable warranty.
4. The obligation of Meridian under this warranty shall not arise unless Meridian is notified and this warranty is presented together with a written statement specifying the claim or defect within thirty (30) days after the failure is first detected or made known to the Purchaser and within: (i) one (1) year, or ninety (90) days in the case of commercial use; or (ii) thirty (30) days in the case of replacement parts and components manufactured by Meridian; from the shipment date from the Meridian dealer (FCA). Meridian in its sole and unfettered discretion shall determine if the claim is valid and whether correction of the defect or failure shall be made by repair or replacement of the materials.
5. Title to any replaced materials Meridian wishes to have pass to it, shall pass to Meridian.
6. The obligation of Meridian hereunder extends only to the original Purchaser or Buyer to whom the Goods were initially sold. This warranty shall not be subject to any assignment or transfer without the written consent of Meridian.
7. The purchaser acknowledges that it has made its own independent decision to approve the use of the Goods and also the specific fabrication and construction procedures utilized to complete the Goods, and has satisfied itself as to the suitability of these products for its use.

8. This warranty is subject to the following limitations, provisions and conditions:
 - a. Meridian shall have no liability hereunder for any claims, including field re-work.
 - b. Meridian shall not be liable for any incidental loss or damage, however caused, including, without limitation, normal wear and tear.
 - c. Meridian makes no express or implied warranties of any nature whatsoever except for such express warranties as set out herein. The warranty provided herein is in lieu of and excludes all other warranties, guarantees or conditions pertaining to the Goods, written or oral, statutory, express or implied, (except the warranty as to title) including any warranty as to the merchantability or fitness for any particular purpose. Meridian expressly disclaims all other representations, conditions or warranties, expressed or implied, statutory or otherwise and any representations, warranties or conditions that may arise from a course of dealing or usage of trade. The warranty provided herein shall constitute Meridian's sole obligation and liability and the Purchaser's sole remedy for breach of warranty. No other warranty has been made by any employee, agent, or representative of Meridian and any statements contained in any other printed material of Meridian is expressly excluded here from. Meridian shall not be responsible for any warranty offered by the Purchaser to its customers with respect to the Goods and the Purchaser shall indemnify Meridian with respect to same if any of those customers makes a claim against Meridian relating to any such warranty.
 - d. Subject to Meridian's obligations contained in paragraphs 1 and 2 herein, none of Meridian, its officers, directors, servants or agents shall be liable, or responsible for any loss or damage (including strict liability and liability for loss or damage due to items which the manufacturing processes are designed to identify) whether such loss or damage is caused by negligence in any manner whatsoever (including gross negligence, error, misrepresentation, misstatement, imprudence, lack of skill or lack of judgement).
9. The sole financial obligation of Meridian under this warranty shall be limited to the repair or replacement of the Goods as originally supplied and in no event shall they exceed the original cost of the Goods supplied.
10. Meridian shall not have any obligation under any warranty herein until all accounts have been paid in full by the Purchaser.
11. The construction and interpretation of this Warranty shall be governed by the laws of the Province of Manitoba.

Register your product at: www.meridianmfg.com
For warranty information send an email to: warranty@meridianmfg.com

WARRANTY REQUEST PROCEDURE

1. The product must be registered with Meridian Manufacturing Inc.
2. The purchaser must contact the dealer, from where the unit was purchased, immediately upon discovery of any defects.
3. A completed Warranty Request (Claim) Form must be submitted by the dealer to the Meridian's warranty representative for review and any subsequent course of action.
 - Warranty requests must be completed with ALL required information in order it to be considered for approval.
 - Send photographs of the entire piece of equipment, and of the specific area of concern.
4. Warranty repair work will only be performed by Meridian or an approved representative of Meridian. Warranty work completed prior to Meridian's approval will NOT be honoured. Failure to follow this procedure may affect any or all of this warranty.
5. All warranty requests will be adjudicated at the sole discretion of Meridian and in accordance with the terms and conditions of the warranty.

CONVEY-ALL[®]

(800) 665-7259 | www.convey-all.com | tenders@convey-all.com