



BULK SEED TENDER

OPERATOR'S MANUAL



112 BST SEED TENDER

PRODUCT WARRANTY REGISTRATION FORM



www.meridianmfg.com

WARRANTY REGISTRATION

This form must be filled out by the dealer and signed by both the dealer and the customer at the time of delivery. Please mail or fax the completed form for validation of the equipment registration.

Customer's Name _____

Address _____

City, State, Postal Code _____, _____, _____

Phone Number (_____) _____ - _____

PRODUCT INFORMATION

Seed Tender Model # _____

Serial Number # _____

I have thoroughly instructed the buyer on the above-described equipment, including review of the Operator's Manual content, equipment care, adjustments, operational use, safety procedures, and applicable warranty policy.

Dealer/Company Name _____

City, State, Postal Code _____, _____, _____

Dealer's Signature _____ Date ____/____/____

The above equipment and Operator's Manual have been received by me, and I have been thoroughly instructed as to care, adjustments, safe operation, and applicable warranty policy.

Owner's Signature _____ Date ____/____/____

2902 Expansion Blvd. Storm Lake, Iowa 50588 Phone: 800-437-2334 Fax: 712-732-1028 Email: iowa_warranty@meridianmfg.com

Cut Here to Remove Page

PRODUCT WARRANTY REGISTRATION FORM



www.meridianmfg.com

DEALER INSPECTION REPORT

- ___ If equipped, check gasoline engine fuel level
- ___ If equipped, check gasoline engine oil level
- ___ If equipped, start gasoline engine
- ___ Inspect brake and lighting wiring harness connection
- ___ Check air pressure in tires
- ___ Make sure electric brakes are in working condition
- ___ Make sure all guards/shields are installed correctly
- ___ Make sure all safety signs are installed and legible
- ___ Reflectors and lights must be clean and working
- ___ Inspect customer's hitch for 2 -5/16" ball
- ___ Verify receipt of all options ordered
- ___ Make sure hitch-to-tongue bolts are tight
- ___ Make sure safety chains are properly attached and are in good working condition
- ___ Wheel nuts/bolts must be tightened to proper torque on all wheels
- ___ Wiring harness plug must be in working condition and fit into tow vehicle's receptacle
- ___ Make sure breakaway cable and pin is supplied with trailer
- ___ Make sure battery is fully charged and in good working order
- ___ Make sure license plate light is operating
- ___ Make sure turn signal lights are operating
- ___ Make sure brake lights are operating
- ___ Verify that tow vehicle is large enough to safely tow the trailer
- ___ Make sure owner is instructed to check wheel bolt/nut torque at 5, 10, 25, and 50 miles; then check annually
- ___ Review safety and operating instructions with owner



2902 Expansion Blvd .
 Storm Lake , IA 50588
 PH# 712 -732-1780
 FAX# 712 -732-1028

Date: ____/____/____

CERTIFICATE OF ORIGIN

LICENSING INFORMATION

DEALER :
 _____ Business
 _____ Contact
 _____ Address
 _____ City, State, Zip

SOLD TO :
 _____ Business
 _____ Contact
 _____ Address
 _____ City, State, Zip

TENDERMODEL # _____

TENDERWEIGHT _____

TENDERSERIAL # _____

(One serial number is issued on complete tender packages. Those trailers do not receive a serial number.)

TRAILER MODEL #: _____

TRAILER SERIAL # _____ TRAILER WEIGHT : _____

Tender 112 BST Wagon	80196	1,004#	Tender 375-BH	80345	6071#
Tender 112 BST-T (trailer included)	80197	1,830#	Tender 375-GN	80346	6721#
Tender 225 RST Wagon	80131	1733#	Tender 375-BWT -BH	80347	6079#
Tender 225 RST -BH	80601	3375#	Tender 375BWT -GN	80348	6729#
Tender 225RST -GN	80602	4097 #	Tender 375RT8 -BWT (trailer included)	80377	5,913#
Tender 225RST -BWT -BH	80603	3577#	Tender 375RT8 -T (trailer included)	80379	5,607#
Tender 225RST -BWT -GN	80604	4299#	Tender Titan 2SE -T (trailer included)	80201	2,254#
Tender 240RT6	80249	2,545#	Tender Titan 2SE -BWT	80616	2302#
Tender 240RT6 -BWT -BH	80253	4,475#	Tender Titan 2-T (11' 10" discharge)	80134	1820#
Tender 240RT6 -BH	80250	4,174#	Tender Titan 2 -T (15' 6" discharge)	80135	1868#
Tender 240RT8	80251	2,604#	Tender T4SEWagon	80401	2,803#
Tender 240RT8-BWT -BH	80248	4,534#	Tender T4SE -T (trailer included)	80402	4,431#
Tender 240RT8 -GN	80255	4,232#	Tender T4SE -BWT (trailer included)	80403	4,833#
Tender 240 RT8 -BWT -GN	80243	4,491#	Tender T4SE -T -GN	80609	4893 #
Tender 375RT6 Wagon	80381	3,094#	Tender 4SE -T -GN -BWT	80608	5235 #
Tender 375RT6 -BH	80324	5,636#	Tender 400 -6SLD	80352	3375 #
Tender 375RT6-BWT -BH	80337	5,942#	Tender 400BH -6SLD	80353	5040 #
Tender 375RT6 -GN	80338	6637#	Tender 400GN -6SLD	80354	5690 #
Tender 375RT8	80382	3476#	Tender 400 -8SLD	80355	3530#
Tender 37 5RT8 Wagon	80376	3106#	Tender400BH -8SLD	80356	5195#
Tender 375RT8 -BH	80326	5760#	Tender 400GN -8SLD	80357	5845 #
Tender 375RT8 -GN	80327	6441#	Tender 405GN-8SLD BASE	40297	4554#
Tender 375RT8 -BWT -BH	80339	5990#	Tender 405GN-8SLD TRIPLE AXLE	80191	6247#
Tender 375RT8 -GN	80340	6672#	Tender 405BN-8SLD TRIPLE AXLE	80192	5679 #
240 -Rear Facing (BH trailer included)	80121	3720#	Tender 405GN-8SLD TANDEM AXLE	80193	6243#
240 -Front Facing (BH trailer included)	80136	3720#	Tender 405BN-8SLD TANDEM AXLE	80194	5715 #
Tender 375 (no trailer)	80349	4207#			

Cut Here to Remove Page

CONTENTS

- 1. INTRODUCTION 11**
 - 1.1 Congratulations 11
 - 1.2 Operator Orientation 11
 - 1.3 Owner/Operator 11

- 2. SAFETY 12**
 - 2.1 General Safety 13
 - 2.2 Equipment Safety Guidelines 14
 - 2.3 Safety Training 14
 - 2.4 Safety Signs 15
 - 2.5 Preparation. 15
 - 2.6 Operating Safety 15
 - 2.7 Maintenance Safety 15
 - 2.8 Lock-Out or Tag-Out Safety 15
 - 2.9 Storage Safety 15
 - 2.10 Transport Safety 15
 - 2.11 Refuelling Safety 15
 - 2.12 Battery Safety. 15
 - 2.13 Sign-Off Form. 16

- 3. SAFETY SIGN LOCATIONS. 17**
 - 3.1 General Information 17
 - 3.2 How to Install Safety Signs. 17
 - 3.3 Decal Locations 17

- 4. SPECIFICATIONS 20**
 - 4.1 Overall Specifications 20
 - 4.2 Bolt Specifications 20
 - 4.2.1 Bolt Torque Values 20
 - 4.2.2 Grade Markings Chart 20

- 5. MACHINE COMPONENTS AND CONTROLS 21**
 - 5.1 Component Nomenclature and Location. 21
 - 5.2 Engine and Controls 22
 - 5.3 Engine Warning Decals 23

- 6. PRE-OPERATING INSTRUCTIONS 24**
 - 6.1 Safety 24
 - 6.2 Machine Break-In Period. 24
 - 6.2.1 Before Starting 24
 - 6.2.2 Inspections for 1/2, 5, and 10 Hours 24
 - 6.3 Daily Pre-Operation Checklist 24

- 7. TOWING 26**
 - 7.1 Transport Safety 26
 - 7.2 Connecting the Trailer 26

- 8. OPERATION. 28**
 - 8.1 Operating Safety 28
 - 8.2 Opening and Closing Bin Cover 28
 - 8.3 Operation. 29
 - 8.3.1 Loading (Filling Seed Tender). 29
 - 8.3.2 Unloading Seed Tender. 30
 - 8.3.3 Unplugging Auger Tube 34

9. STORAGE	35
9.1 Storage Safety	35
9.2 General Information	35
9.3 Placing in Storage	35
9.4 Removing from Storage	35
10. MAINTENANCE	36
10.1 Safety	36
10.1.1 General Safety	36
10.1.2 Lock-Out or Tag-Out Safety	36
10.2 Lubrication	37
10.2.1 Wheel Bearings	37
10.2.2 Auger Tube Pivot Shaft.	37
10.2.3 Seed Bin Cover.	37
10.3 Battery	38
10.3.1 Battery Safety	38
10.3.2 Battery Replacement and Maintenance Tips	38
10.3.3 Battery Maintenance.	38
10.4 Engine	39
10.4.1 Refuelling Safety	39
10.4.2 Approved Fuel	39
10.4.3 Engine Oil	39
10.4.4 Change Engine and Reduction Case Oil	39
10.4.5 Clean Air Cleaner	40
10.4.6 Engine Circuit Protection	40
10.5 Engine Actuator Replacement	40
10.5.1 Actuator Removal	40
10.5.2 Actuator Installation	41
10.6 Unplugging Auger Delivery Tube	42
10.7 Auger Drive Belt	43
10.7.1 Drive Belt Tension	43
10.7.2 Drive Belt Installation	43
10.8 Engine Speed Setting.	43
10.9 Trailer Break-Away System.	44
10.9.1 Testing the Battery.	44
10.9.2 Changing Battery	44
10.9.3 Replacing Battery	45
10.10 Wheel Bolt Torque Requirements	45
10.11 Axle Bolts and Frame Hold-Down Bolts	45
10.12 Service Record Chart	46
10.13 Service Checks	47
10.13.1 Daily (8 Hours)	47
10.13.2 Weekly (50 Hours)	47
10.13.3 Annually (400 Hours).	47
10.14 Axle Maintenance	47
10.14.1 First 200 Miles	47
10.14.2 3,000 Miles or 3 Months	47
10.14.3 6,000 Miles or 6 Months	48
10.14.4 12,000 Miles or 12 Months.	48
10.15 Tires	48
10.16 Welding Repairs.	48

11. OEM LITERATURE	49
11.1 Honda® Engine	49
11.2 Axle	49
12. TROUBLESHOOTING	50
12.1 Troubleshooting Chart	50
13. WARRANTY	51
13.1 Warranty Statement	51
14. PARTS	52
14.1 112BST Seed Tender	53
14.2 112BST Seed Tender Frame	54
14.3 112BST Upper Auger Tube	56
14.4 112BST Lower Auger Tube	57
14.5 112BST Three Tier Spout	58
14.6 112BST Trailer	59

1. INTRODUCTION

1.1 CONGRATULATIONS

Congratulations on your choice of a Meridian Manufacturing 112BST Bulk Seed Tender to complement your seed delivery system in your farming operation. This equipment has been designed and manufactured to meet the exacting standards for such equipment in the agricultural industry and will keep your seed delivery system at optimum efficiency.



The Bulk Seed Tender system is designed to handle any kind of bulk seed, quickly transport it, and then transfer it into planters and drills, as required.

Safe, efficient, and trouble-free operation of your Bulk Seed Tender requires that you and anyone else who will be operating or maintaining the machine, read and understand the Safety, Operation, Maintenance, and Troubleshooting information contained within this Operator's Manual.

This manual covers the 112BST model manufactured by Meridian Manufacturing, Inc. Use the Table of Contents as a guide to locate required information.



1.2 OPERATOR ORIENTATION

The directions left, right, front, and rear, as mentioned throughout this manual, are as seen from the truck drivers' seat and facing in the direction of travel.

1.3 OWNER/OPERATOR

It is the responsibility of the owner or operator to read this manual and to train all other operators before they start working with the machine. Follow all safety instructions exactly. Safety is everyone's business. By following recommended procedures, a safe working environment is provided for the operator, bystanders, and the area around the work site. Untrained operators are not qualified and must not operate the machine.

In addition to the design and configuration of equipment, hazard control and accident prevention are dependent upon the awareness, concern, prudence, and proper training of personnel involved in the operation, transport, maintenance, and storage of equipment. It is the responsibility of the owner or operator to read this manual and to train all operators before they start working with the machine. Follow all safety instructions as laid out in this manual.

Keep this manual handy for easy reference and to pass on to new operators or owners. Call your Meridian Manufacturing, Inc. dealer if you need assistance, information, or additional copies of the manuals.

The information, specifications, and illustrations in this manual are those in effect at the time of printing. We reserve the right to change specifications or design at any time without notice.

2. SAFETY

SAFETY ALERT SYMBOL

This Safety Alert symbol means
ATTENTION! BECOME ALERT!
YOUR SAFETY IS INVOLVED!



The Safety Alert symbol identifies important safety messages on the Meridian Bulk Seed Tender Models and in the manual. When you see this symbol, be alert to the possibility of personal injury or death. Follow the instructions in the safety message.

WHY IS SAFETY IMPORTANT TO YOU?

3 Big Reasons

- Accidents Disable and Kill •
- Accidents Cost •
- Accidents Can Be Avoided •

SIGNAL WORDS:

Note the use of the signal words **DANGER**, **WARNING**, and **CAUTION** with the safety messages. The appropriate signal word for each message has been selected using the following guidelines:

CAUTION - Indicates a potentially hazardous situation that, if not avoided, may result in minor or moderate injury. It may also be used to alert against unsafe practices.

WARNING - Indicates a potentially hazardous situation that, if not avoided, could result in death or serious injury, and includes hazards that are exposed when guards are removed. It may also be used to alert against unsafe practices.

DANGER - Indicates an imminently hazardous situation that, if not avoided, will result in death or serious injury. This signal word is to be limited to the most extreme situations typically for machine components which, for functional purposes, cannot be guarded.





If you have any questions not answered in this manual, require additional copies of the manual, or the manual is damaged, please contact your dealer or Meridian Manufacturing, 2902 Expansion Blvd., Storm Lake, Iowa, 50588, toll free 1-800-437-2334, phone (712) 732-1780, or fax (712) 732-1028.





YOU are responsible for the **SAFE** operation and maintenance of your Meridian Manufacturing Bulk Seed Tender. **YOU** must ensure that you and anyone else who is going to operate, maintain, or work around the Bulk Seed Tender be familiar with the operating and maintenance procedures and related **SAFETY** information contained in this manual. This manual will take you step-by-step through your working day and alert you to all good safety practices that should be adhered to while operating the Bulk Seed Tender system.







Remember, **YOU** are the key to safety. Good safety practices not only protect you but also the people around you. Make these practices a working part of your safety program. Be certain that **EVERYONE** operating this equipment is familiar with the recommended operating and maintenance procedures and follow all the safety precautions. Most accidents can be prevented. Do not risk injury or death by ignoring good safety practices.

- Bulk Seed Tender system owners must give operating instructions to operators or employees before allowing them to operate the machine, and then annually thereafter per OSHA (Occupational Safety and Health Administration) regulation 1928.57.
- The most important safety feature on this equipment is a **SAFE** operator. It is the operator's responsibility to read and follow **ALL** Safety and Operating instructions in the manual. Most accidents can be avoided.
- A person who has not read and understood all operating and safety instructions is not qualified to operate the machine. An untrained operator exposes himself and bystanders to possible serious injury or death. Always be and stay alert to any possible unsafe operating or maintenance procedures or conditions.
- Do not modify the equipment in any way. Unauthorized modification may impair the function and/or safety of the components and systems and could affect the life of the equipment, possibly invalidating the warranty coverage.
- Think SAFETY! Work SAFELY!

2.1 GENERAL SAFETY

1.  Read and understand the Operator's Manual and all safety signs before operating, maintaining, adjusting, filling, unloading, or unplugging the Bulk Seed Tender system.
2.  Have a first aid kit available for use should the need arise and know how to use it.
3.  Have a fire extinguisher available for use should the need arise and know how to use it.
4.  Do not allow riders.
5. When working around or operating this equipment, wear appropriate personal protective equipment. This list includes but is not limited to:

 - A hard hat
 - Protective shoes with slip resistant soles
 - Protective goggles, glasses, or face shield
 - Heavy gloves and protective clothing
 - Respirator
6.  Do not allow long hair, loose fitting clothing, or jewelry around equipment.
7.  Install and secure all guards before starting.
8.  Stop engine, remove ignition key, and wait for all moving parts to stop before servicing, repairing, adjusting, loading, filling, or unplugging.
9.   Establish a lock-out or tag-out policy for the work site. Be sure all personnel are trained in and follow all procedures. Lock-out or tag-out all power sources before working around loading/unloading equipment.
10.  Clear the area of people, especially small children, before starting.
11.  Review safety related items annually with all personnel who will be operating, using, or maintaining the Bulk Seed Tender system.

2.2 EQUIPMENT SAFETY GUIDELINES

1. Safety of the operator and bystanders is one of the main concerns in designing and developing a machine. However, every year many accidents occur which could have been avoided by a few seconds of thought and a more careful approach to handling equipment. You, the operator, can avoid many accidents by observing the following precautions in this section. To avoid personal injury or death, study the following precautions and insist those working with you, or for you, follow them.
2. In order to provide a better view, certain photographs or illustrations in this manual may show an assembly with a safety shield removed. However, equipment should never be operated in this condition. Keep all shields in place. If shield removal becomes necessary for repairs, replace the shield prior to use.
3. Never use alcoholic beverages or sedative drugs while operating this equipment. Consult your doctor about operating this machine while taking prescription medications.
4. Do not allow persons to operate or assemble this unit until they have read this manual and have developed a thorough understanding of the safety precautions and how it works. Review the safety instructions with all users annually.
5. Under no circumstances should young children be allowed to work with this equipment. This equipment is dangerous to children and persons unfamiliar with its operation. The operator should be a responsible, properly trained, and physically able person familiar with farm machinery and trained in this equipment's operations. If the elderly are assisting with farm work, their physical limitations need to be recognized and accommodated.
6. Never exceed the limits of a piece of machinery. If its ability to do a job, or to do so safely, is in question - **DON'T TRY IT.**
7. Do not modify the equipment in any way. Unauthorized modification may result in serious injury or death and may impair the function and life of the equipment.

8. In addition to the design and configuration of this implement, including Safety Signs and Safety Equipment, hazard control and accident prevention are dependent upon the awareness, concern, prudence, and proper training of personnel involved in the operation, transport, maintenance, and storage of the machine. Refer to Safety Messages and operation instruction in each of the appropriate sections of the auxiliary equipment and machine Manuals. Note all Safety Signs affixed to the auxiliary equipment.

2.3 SAFETY TRAINING

1. Safety is a primary concern in the design and manufacture of our products. Unfortunately, our efforts to provide safe equipment can be wiped out by a single careless act of an operator or bystander.
2. In addition to the design and configuration of equipment, hazard control and accident prevention are dependent upon the awareness, concern, prudence, and proper training of personnel involved in the operation, transport, maintenance, and storage of this equipment.
3. The best safety feature is an informed, careful operator. It is the operator's responsibility to read and comply with ALL Safety and Operating instructions in the manual. Accidents can be avoided.
4. Working with unfamiliar equipment can lead to injuries. Read this manual, as well as the manual for your auxiliary equipment, before assembling or operating to acquaint yourself with the machines. If this machine is used by any person other than yourself, it is your responsibility to make certain that the operator reads and understands the operator's manuals and is instructed in safe and proper use.
5. Know your controls and how to immediately stop augers, conveyors, and any other auxiliary equipment in an emergency. Read this manual and the one provided with all auxiliary equipment.
6. Train all new personnel and review instructions frequently with employees. Be certain only a properly trained and physically able person will operate the machinery. A person who has not read and understood all operating and safety instructions is not qualified to operate the machine. An untrained operator exposes himself and bystanders to possible serious injury or death.

2.4 SAFETY SIGNS

Refer to the Safety Signs section for safety information.

2.5 PREPARATION

Refer to the Preparation section for safety information.

2.6 OPERATING SAFETY

Refer to the Operating section for safety information.

2.7 MAINTENANCE SAFETY

Refer to the Maintenance section for safety information.

2.8 LOCK-OUT OR TAG-OUT SAFETY

Refer to the Maintenance section for safety information.

2.9 STORAGE SAFETY

Refer to the Storage section for safety information.

2.10 TRANSPORT SAFETY

Refer to the Towing section for safety information.

2.11 REFUELLING SAFETY

Refer to the Engine section for safety information.

2.12 BATTERY SAFETY

Refer to the Battery section for safety information.

3. SAFETY SIGN LOCATIONS

3.1 GENERAL INFORMATION

The types of safety signs and locations on the equipment are shown in the following pages. Good SAFETY AWARENESS requires that you familiarize yourself with the various safety signs, the type of warning and the area, or a particular function related to that area.

-  If safety signs have been damaged, removed, become illegible, or parts replaced without signs, new signs must be applied.
- Replacement parts that displayed a safety sign should also display the current sign.
- Replacement safety signs (labels) are available from your authorized Dealer Parts Department or the factory at no cost.

3.2 HOW TO INSTALL SAFETY SIGNS

- Be sure that the installation area is clean and dry.
- Be sure temperature is above 50°F (10°C).
- Determine exact position before you remove the backing paper.
- Remove the smallest portion of the split backing paper.
- Align the sign over the specified area and carefully press the small portion with the exposed sticky backing in place.
- Slowly peel back the remaining paper and carefully smooth the remaining portion of the sign in place.
- Small air pockets can be pierced with a pin and smoothed out using a piece of sign backing paper.

3.3 DECAL LOCATIONS

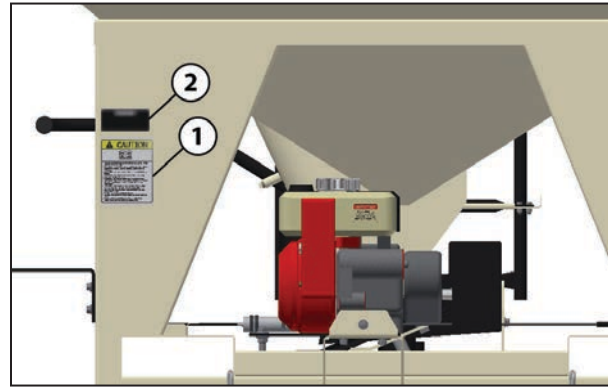

- CAUTION — Read Operators Manual (#19934)

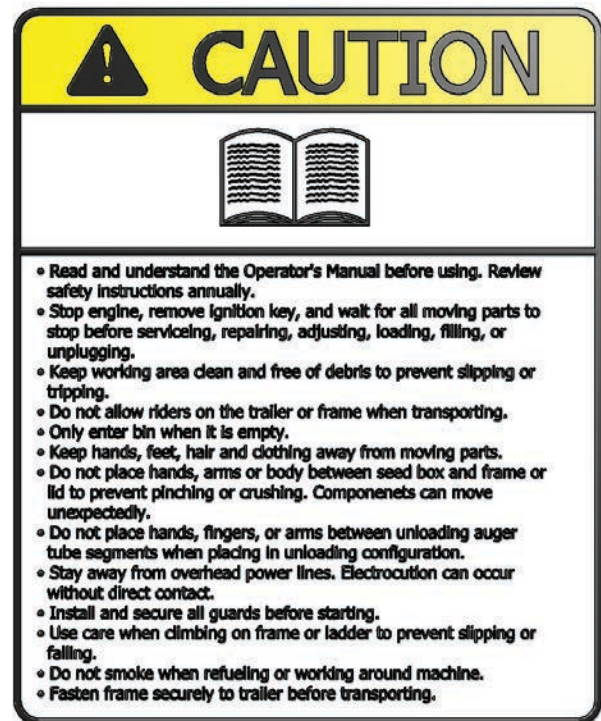

- Product Serial Number Decal (#19984)



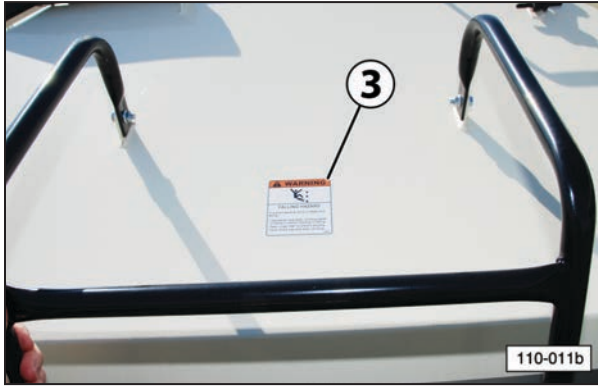

3. WARNING — Falling Hazard (#19939)

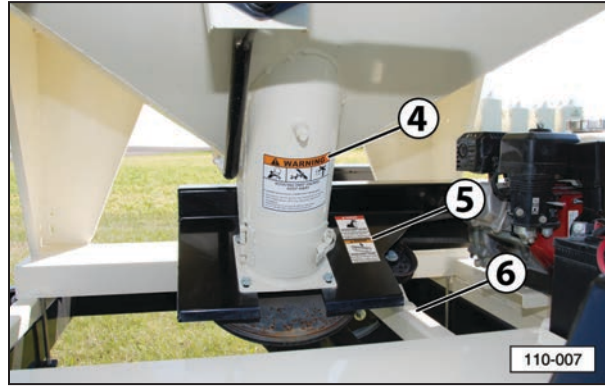

4. WARNING — Rotating Part Hazard (#19936)



5. WARNING — Missing Shield Hazard (#19937)



6. DANGER — Rotating Part Hazard (#18435)





 DANGER

ENTANGLEMENT HAZARD
<ul style="list-style-type: none">• Do not operate without guard.• Install and secure guard before operating.• Contact with rotating parts will result in serious injury or death.
18435

8. WARNING — Pinch Point Hazard (#19935)

 WARNING
 
PINCH POINT HAZARD
Avoid serious injury from pinching or crushing:
<ul style="list-style-type: none">• Keep hands and fingers clear of pivot joint when raising or lowering upper auger tube.• Always maintain secure footing when raising or lowering auger tube.
19935

7. WARNING — Crush/Electrocution Hazard (#17509)

 WARNING 			
	CRUSH HAZARD		ELECTROCUTION HAZARD
	Keep hands and arms clear of conveyor tube when placing it in storage position. Weight of tube will cause crushing injuries.		Avoid contact with overhead power lines or electrically powered objects.
			<ul style="list-style-type: none">• Be aware of your surroundings when raising or lowering conveyor.• Maintain at least 20 feet between equipment and any electrical hazard.• Contact with electricity can result in serious personal injury or death.

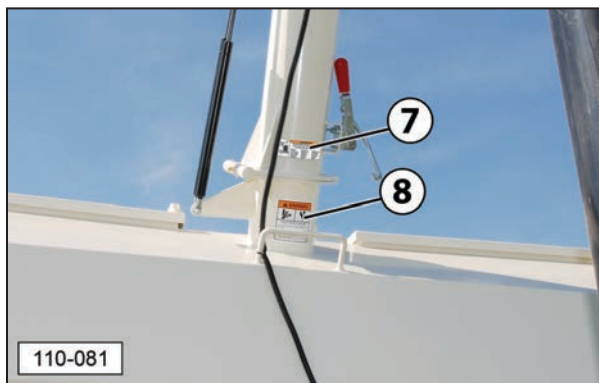

4. SPECIFICATIONS

4.1 OVERALL SPECIFICATIONS

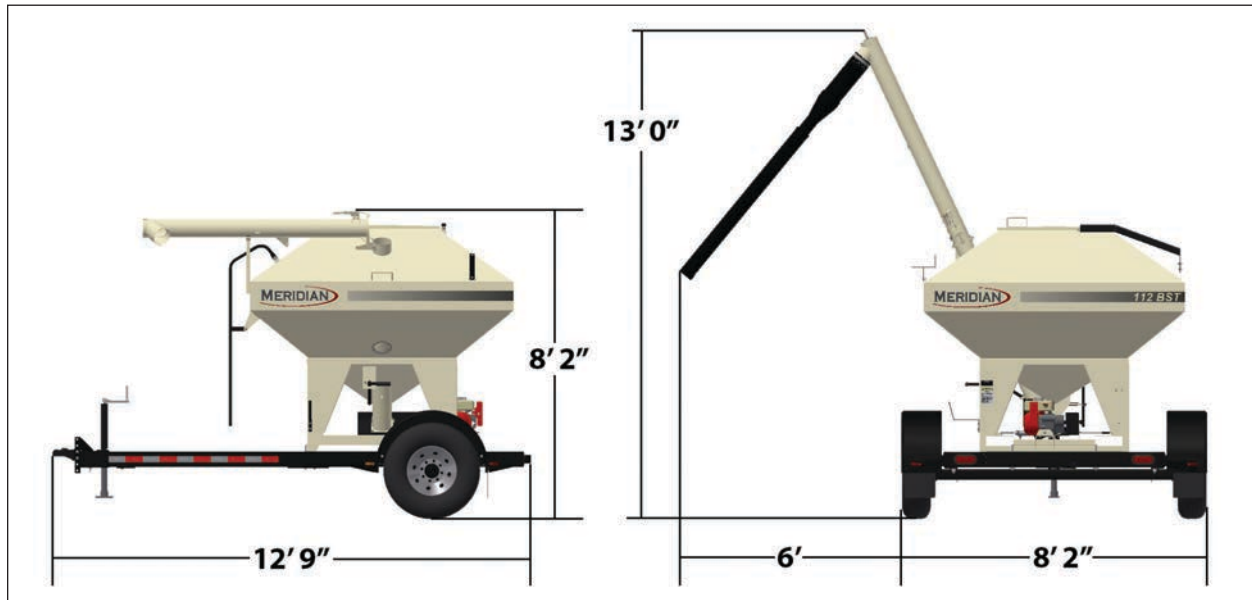

4.2 BOLT SPECIFICATIONS

⚠ WARNING



EQUIPMENT FAILURE HAZARD

The torque value for bolts and capscrews are identified by their head markings. Replacing higher “Grade” bolts (Grade 8) with lower “Grade” bolts (Grade 5) will lead to equipment failure and can result in injury or death. Always use replacement bolts with the same Grade markings as the removed bolt.

4.2.1 Bolt Torque Values

Torque figures indicated above are valid for non-greased or non-oiled threads and heads unless otherwise specified. Therefore, do not grease or oil bolts or capscrews unless otherwise instructed in this manual. When using locking elements, increase torque values by 5%.

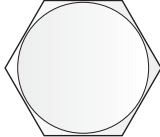
4.2.2 Grade Markings Chart

 No Marking	Grade 2 Low or Medium Carbon Steel
 3 Radial Lines	Grade 5 Medium Carbon Steel Quenched and Tempered
 6 Radial Lines	Grade 8 Medium Carbon Alloy Steel, Quenched and Tempered

Bolt Diameter “A”	SAE Grade 2 N-m (ft-lbs)		SAE Grade 5 N-m (ft-lbs)		SAE Grade 8 N-m (ft-lbs)	
	N-m	(ft-lbs)	N-m	(ft-lbs)	N-m	(ft-lbs)
1/4"	8	(6)	12	(9)	17	(12)
5/16"	13	(10)	25	(19)	36	(27)
3/8"	27	(20)	45	(33)	63	(45)
7/16"	41	(30)	72	(53)	100	(75)
1/2"	61	(45)	110	(80)	155	(115)
9/16"	95	(70)	155	(115)	220	(165)
5/8"	128	(95)	215	(160)	305	(220)
3/4"	225	(165)	390	(290)	540	(400)
7/8"	230	(170)	570	(420)	880	(650)
1"	345	(225)	850	(630)	1320	(970)

5. MACHINE COMPONENTS AND CONTROLS

5.1 COMPONENT NOMENCLATURE AND LOCATION

The Meridian seed tender is designed as a bulk seed transfer unit to transport large amounts of seed into a planter or drill.

Bulk seed can be loaded into the single, seed compartment from a variety of sources including seed boxes. The large seed bin cover (1) slides open on two slide rails to provide an adequate opening for loading the seed. Open the cover using ladder (16).



(1) Seed Bin Cover. (2) Seed Bin Cover Rails. (3) Seed Tender Frame. (4) Trailer. (5) Gasoline Engine.



(6) Trailer Safety Chains. (7) Jack Stand. (8) Break-Away Trailer Brake System. (9) Document Storage Tube (inside of frame). (10) Delivery Spout Storage Bracket. (11) Slide Gate Lever. (12) View Glass. (13) Auger/Engine Throttle Switch. (14) Delivery Spout. (15) Auger Tube. (16) Ladder.

Once the unit is filled, the side mounted auger transfers the seed through auger tube (15) and delivery spout (14) into planters or drills. Slide gate lever (11) on the seed compartment controls the flow of seed into the auger.

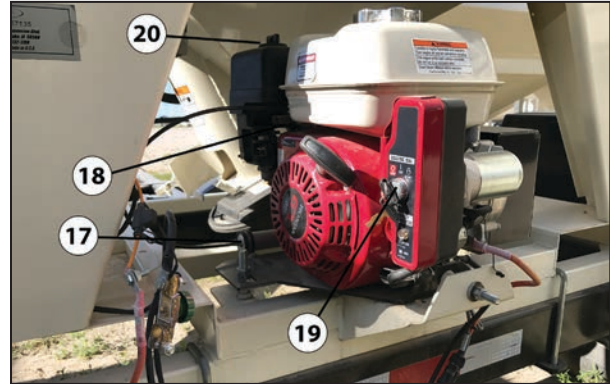

(17) Auger-Speed Actuator. (18) Gas Engine Controls. (19) Gas Engine On/Off Controls. (20) Air Filter.

Gas engine (5) mounted on the frame powers the auger drive pulley (22). A reduction case centrifugal clutch on the engine output shaft engages when the engine speed reaches 1400 RPM. The auger belt drive system (30) transmits power from the engine to the auger. Use auger throttle switch (13) to increase or decrease the speed of the auger.

The auger will only unload to the left side. A telescoping spout on the end of the auger allows for convenient distribution.

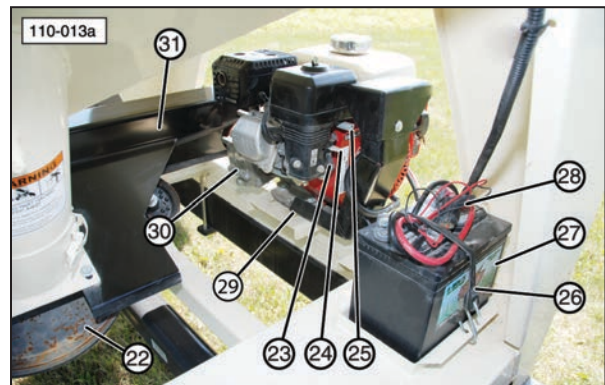

(22) Auger Drive Pulley. (23) Choke Lever. (24) Fuel Shut-Off Lever. (25) Throttle Lever (connected to auger speed actuator). (26) Battery Hold Down Strap (27) Battery. (28) Electrical System Fuse. (29) Auger-Speed Actuator. (30) Centrifugal Clutch Reduction Case. (31) Auger Belt Drive and Guard.

5.2 ENGINE AND CONTROLS

A Honda® engine is used with this unit. Always read the engine Operator's Manual supplied with the seed tender for the detailed engine operating procedures.

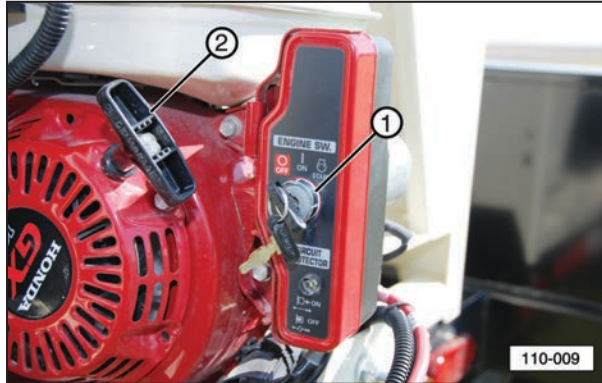

1. Engine Key Switch

Turn the key switch to the START position to start the engine. When the engine starts, then release the key and allow it to return to the ON position.

2. Starting Rope

This retracting rope and T-bar is an optional method used to start the engine. Grasp the T-bar firmly and pull the rope sharply to start the engine. The key on master control must be ON for the engine to start.

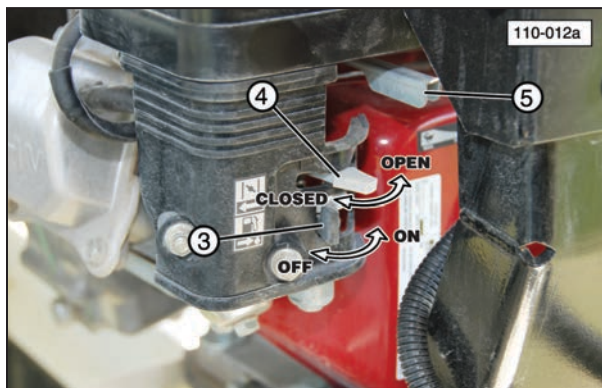

3. Fuel Shut-Off Valve

Each engine is equipped with a valve between the fuel tank and the carburetor. Slide the fuel valve toward the engine to turn ON and away for OFF. Turn the fuel OFF when not in use or before transporting.

4. Choke Lever

The choke lever controls the fuel/air mixture to the engine. Close the choke when starting if the engine is cold. Open the choke as the engine warms. Always open the choke fully during operation.

5. Throttle Lever

This lever controls the engine RPM. Move the lever to increase or decrease the RPM. Always run at maximum throttle when operating the auger.

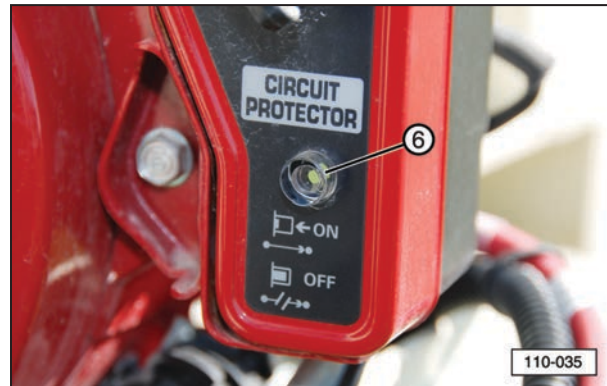

6. Engine Circuit Protection

The circuit protector protects the battery charging circuit. A short circuit, or a battery connected with reverse polarity, will trip the circuit breaker. The green indicator inside the circuit protector will pop out to show that the circuit protector has switched off.



7. Battery (12 Volt)

A 12 Volt battery supplies the power to start the gasoline engine. The battery must be periodically recharged from an external source to keep it fully charged.

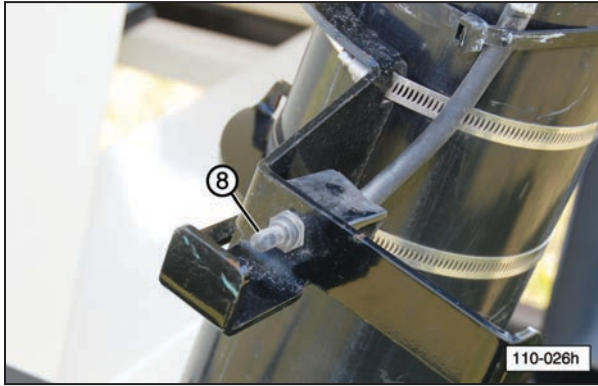

8. Auger/Engine Throttle Switch

This two-position toggle switch controls the throttle for the engine. Move the switch to the right to increase the engine speed and to the left to decrease the speed.

Note: The switch can be moved to any convenient location by relocating the switch and wiring harness.

5.3 ENGINE WARNING DECALS



1. WARNING — Read Owner's Manual (contact Honda Mfg. for replacement of this decal)

! WARNING

Gasoline is highly flammable and explosive. Turn engine off and let cool before refueling.

The engine emits toxic carbon monoxide. Do not run in an enclosed area.

Read Owner's Manual before operation.

2. CAUTION — Shut Off Fuel (contact Honda Mfg. for replacement of this decal)

! CAUTION

Shut off fuel when not in use.

3. IMPORTANT — Battery Recharging (#19991)

IMPORTANT

- **Engine does not recharge battery.**
- **Manually recharge battery periodically.**

19991





4. CAUTION — Hot Muffler (contact Honda Mfg. for replacement of this decal)

! CAUTION

HOT MUFFLER CAN BURN YOU.
Stay away if engine has been running.

6. PRE-OPERATING INSTRUCTIONS

6.1 SAFETY

-  Never operate the seed delivery system and auxiliary equipment until you have read and completely understand this manual, the auxiliary equipment Operator's Manual, and each of the Safety Messages found on the safety signs on the delivery system and auxiliary equipment.
-  **PROLONGED EXPOSURE TO LOUD NOISE MAY CAUSE PERMANENT HEARING LOSS!** Motors or equipment can be noisy enough to cause permanent or partial hearing loss. We recommend that you wear hearing protection on a full-time basis if the noise in the operator's position exceeds 80db. NOTE: Hearing loss from loud noise (tractors, chain saws, radios, and other such sources close to the ear) is cumulative over a lifetime with uncertain natural recovery.
-  Clear working area of debris, trash, or hidden obstacles that might be hooked or snagged, causing injury, damage, or tripping.
- Operate only in daylight or good artificial light.
- Be sure machine is properly attached to the trailer, adjusted, and in good operating condition.
-  Ensure that all guards, shielding, and safety signs are properly installed and in good condition.
-  Before starting, give the machine a "once over" for any loose bolts, worn parts, cracks, leaks, frayed belts, and make necessary repairs. Always follow maintenance instructions.

6.2 MACHINE BREAK-IN PERIOD

A special break-in procedure has been developed to ensure the integrity of the seed tender when first put into service. Follow the Before Starting instructions and then follow the Inspections for 1/2, 5, and 10 Hours instructions at the appropriate interval.

After completing these instructions, follow the normal service schedule in the Maintenance section and engine manual.

6.2.1 Before Starting

- Read and follow the instructions in the Honda® engine and the Meridian Operator's Manuals.
- Review and follow the Pre-operation Checklist before starting machine.
- Initially check wheel bolt torque and then again at 10, 25, and 50 miles. Refer to the Wheel Bolt Torque Requirements section in this manual for tightening instructions.
- Start the engine and check the controls. Be sure that they function properly.

6.2.2 Inspections for 1/2, 5, and 10 Hours

- Recheck the engine and reduction case fluid levels. Refill, as required.
- Recheck the tension and alignment of the auger tube drive belt.
- Recheck hardware and fasteners; frame to trailer tie-downs, all fasteners, and wheel bolts. Tighten to their specified torque.
- At 10 hours, change the engine oil with the specified oil.

6.3 DAILY PRE-OPERATION CHECK-LIST

Efficient and safe operation of the Meridian Bulk Seed Tender system requires that each operator reads and follows the operating procedures and all related safety precautions outlined in this section.

A preoperational checklist is provided for the operator. It is important for both personal safety and maintaining the efficient operation of the delivery system that this checklist be followed.

Before operating the delivery system and each time thereafter, the following areas should be checked:

- Lubricate the machine, as outlined and shown in the lubrication photos in the Maintenance section of this manual. Follow the prescribed schedule.
- Check the engine fluid levels, fuel, and reduction case oil level. Add, as required.





IMPORTANT

The engine warranty is void if the engine is run without oil.

3. Check the oil level in the engine's centrifugal clutch reduction case.
4. Check hardware and fasteners; seed tender frame to trailer tie-downs, hitch bolts, trailer hitch to trailer bolts, and all other fasteners. Tighten to their specified torque.
5. Make sure the wheel bolt lug nuts are tight.
6. Check the tires and ensure that they are inflated to their specified pressure.
7. Remove all entangled material.
8. Visually inspect the auger, auger tube, and delivery spout for damage.
9. Test the Break-Away brake unit and the trailer brakes.
 - a. Make sure the trailer brakes are operating properly.
 - b. Make sure the trip wire to the break-away switch is connected to the tow vehicle.
 - c. Make sure the pin is correctly installed in the break-away switch.
 - d. Press the Test button. The indicator should illuminate green. If the red light illuminates, the battery charge is low. Refer to the Break-Away System in the Maintenance section for instructions on charging the battery.
10. Check the tension of the auger drive belt. Follow the instructions in the manual to correct the tension and/or alignment.

7. TOWING

7.1 TRANSPORT SAFETY

-  Comply with local, state, and federal laws governing safety and conveyance of farm machinery on public roads.
- Ensure all lights, reflectors, and other lighting requirements are installed and in good working condition.
- Ensure that the trailer is equipped with brakes that are in good working order. Be familiar with their operation.
- Do not exceed a safe travel speed. Slow down for rough terrain and when cornering.
-  Fasten frame securely to trailer before transporting.
- Be sure the trailer is securely hitched to the towing vehicle and a retainer is used through the hitch jaws. Always attach a safety chain between the hitch and the towing vehicle.
-  Stay away from overhead power lines. Electrocutation can occur without direct contact.
- Plan your route to avoid heavy traffic.
- Install auger spout transport lock before transporting.
- Do not drink and drive.
- Be a safe and courteous driver. Yield to oncoming traffic in all situations, including narrow bridges, intersections, etc. Watch for traffic when operating near or crossing roadways.
-  Never allow riders on the tender or the trailer.

7.2 CONNECTING THE TRAILER

WARNING



UPENDING HAZARD

To prevent serious injury or death from upending hazard, do not stand over hitch when unhooking the trailer from the tow vehicle.

- Complete the Pre-operation Checklist.

WARNING



CRUSH HAZARD

Ensure that all bystanders, especially small children, are clear of the working area. Ensure there is enough room and clearance to safely back up to the machine.

- Use the trailer jack to lift the hitch above the height of the receiver on the tow vehicle (standard hitch assembly shown).



- Remove the retainer pin. Release or open the receiver by pulling the locking cover back, as shown.

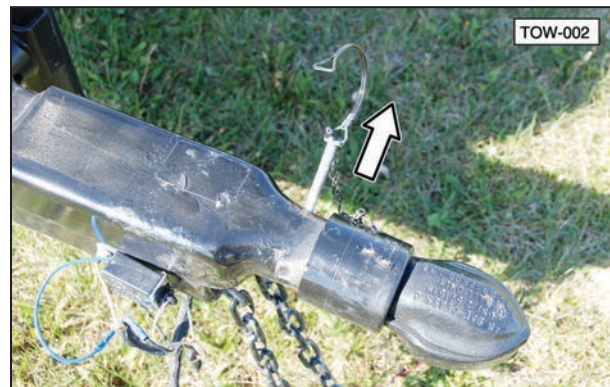

4. Slowly back the tow vehicle until the hitch and ball are aligned.



5. Lower the hitch onto the ball.



6. Raise the jack and place it in its stowed position.

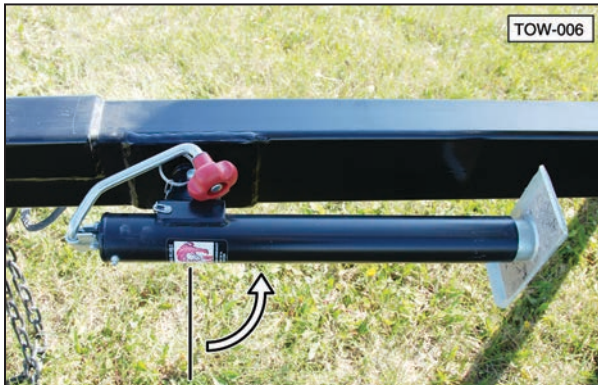

7. Close the receiver by pulling the spring loaded locking collar back to release the hitch mechanism. Install the retainer clip to prevent unwanted opening of the receiver.

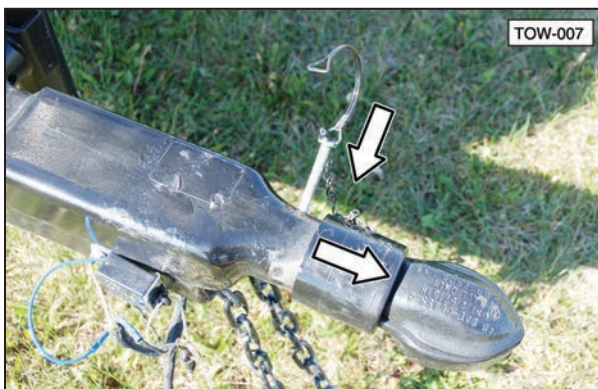

8. Attach the safety chain securely to the tow vehicle to prevent unexpected separation. Cross the chains when attaching.



9. Connect the wiring harness for the lights and brakes.



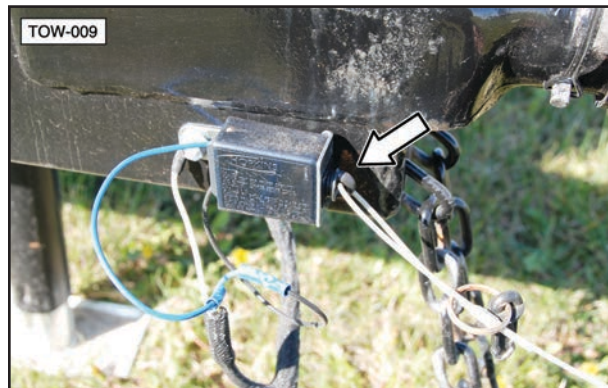











10. Connect the break-away system cable to the tow vehicle. Make sure the key on the end of the cable is properly plugged into the receiving unit.



11. Route all the cables in a manner that will prevent snagging. Be sure to provide slack for turning.

8. OPERATION

8.1 OPERATING SAFETY

-  Make sure that anyone who will be operating the Bulk Seed Tender system or working on or around the unit reads and understands all the operating, maintenance, and safety information in the operator's manual.
-  Keep all bystanders, especially children, away from the machine when loading or unloading, or when authorized personnel are carrying out maintenance work.
-   Establish a lock-out or tag-out policy for the work site. Be sure all personnel are trained in and follow all procedures. Lock-out or tag-out all power sources before servicing the unit or working around loading/unloading equipment.
-  Stop engine, remove ignition key, and wait for all moving parts to stop before servicing, repairing, adjusting, loading, filling, or unplugging.
-   Keep working area clean and free of debris to prevent slipping or tripping.
-  Do not allow riders on the trailer or frame when transporting.
-  Keep hands, feet, hair, and clothing away from rotating parts.
-  Do not place hands, fingers, or arms between moving parts.
-  Stay away from overhead power lines. Electrocution can occur without direct contact.
-  Install and secure all guards before starting.
-  Use care when climbing on frame or ladder to prevent slipping or falling.
-  Fasten frame securely to trailer before transporting.
-  Review safety related items annually with all personnel who will be operating, using, or maintaining the seed delivery system.

8.2 OPENING AND CLOSING BIN COVER

WARNING



FALL HAZARD

- Follow the instructions and use good judgement whenever climbing the ladder. Failure to follow these instructions can result in serious injury or death from falling.

1. Do not climb ladder with muddy or slippery boots.
2. Keep rungs of ladder clean and free of debris.
3. Have a firm footing on the ladder and a firm handhold before releasing the rubber latch or opening/closing the cover.
4. Make sure the hazard decal is attached to the seed tender and is legible. Replace the decal if it is not legible with part number 19939.



WARNING



-
-
-

FALLING HAZARD

Avoid serious injury or death from falling:

- **Grip the ladder with both hands when climbing to prevent slipping or falling.**
- **Keep rungs clean to prevent slipping.**

19939

1. Carefully climb the ladder.



2. Release the rubber latch on the cover.



3. Raise the cover and push it forward.



4. Continue to push the cover forward until it is fully opened.



5. When the bin is filled, close the cover and lock it in place with the rubber latch.

IMPORTANT

Make sure the cover is closed and the rubber latch is locked in place before towing the seed tender.

Failure to lock the rubber latch could allow the cover to blow open, resulting in damage to the unit.

8.3 OPERATION

This Operation section provides a step-by-step procedure for first loading seed into the seed tender at the farm and then unloading it in the field.

IMPORTANT

Ensure tender unit is securely hooked up to a proper tow vehicle before loading or unloading the unit.

8.3.1 Loading (Filling Seed Tender)

1. Connect the seed tender to a suitable towing vehicle. **Follow all related safety instructions in the Towing and the Safety sections of this manual.**

IMPORTANT

The seed tender, when fully loaded, can weigh 7,500 lbs. (3,402 kg.). Ensure the tow vehicle has the capacity to safely tow a fully loaded seed tender.

2. Before loading, shut off the engine of the tow vehicle, set the parking brake, and remove the ignition key, and wait for all moving parts to stop before leaving cab.

- Open the cover of the seed tender and fill it with seed from a storage box, storage bag, or other means. **Follow the safety instructions in the Opening and Closing Bin Cover section of this manual.**



- When the bin is filled, close the cover and lock it in place with the rubber latch.

IMPORTANT

Make sure the cover is closed and the rubber latch is locked in place before towing the seed tender. Failure to lock the rubber latch could allow the cover to blow open, resulting in damage to the unit.

- Move the unit to the location of the planting equipment following all safe towing practices.

8.3.2 Unloading Seed Tender

The seed tender will only unload from the left side.

- Position the seed tender near the planter.
- Before unloading, shut off the engine of the tow vehicle, set the parking brake, and remove the ignition key, and wait for all moving parts to stop before leaving the cab.
- Check the surrounding area for overhead power lines that would contact the auger tube in its raised position. **Contact with electricity can result in serious personal injury or death.**

⚠ WARNING



ELECTROCUTION HAZARD
Avoid contact with overhead power lines or electrically powered objects.

- Be aware of your surroundings when raising or lowering any part of the equipment.
- Maintain at least 20 feet between the equipment and any electrical hazard.
- Contact with electricity can result in serious personal injury or death.

- Unlatch the rubber tie-down strap from the delivery spout.

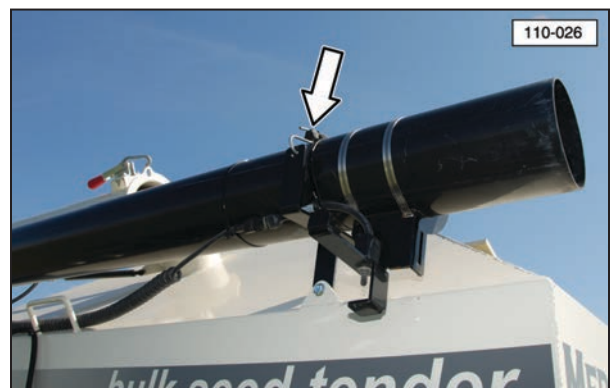

- Lower the delivery spout to the ground.



- Make sure the auger cable is threaded into the hole in the end of the auger. Damage to the auger can occur if the cable is not properly inserted.

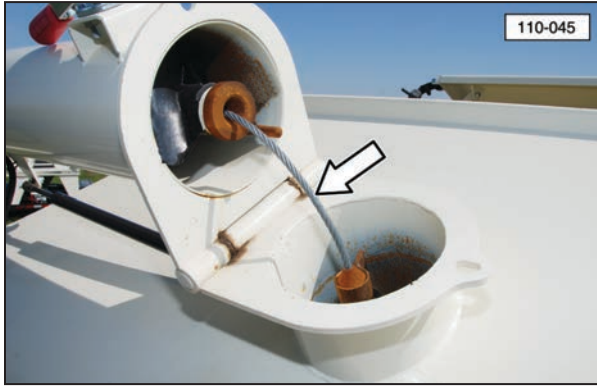

110-045

IMPORTANT

Before raising the auger tube, make sure the electrical control cable is not wrapped around the auger support post. If the cable is not able to move freely, it can be damaged when the auger tube is lifted into place.

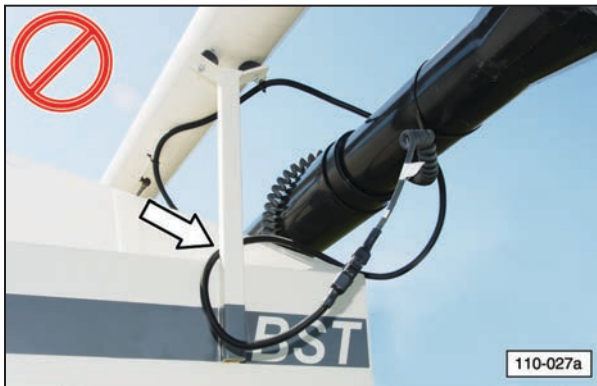

110-027a

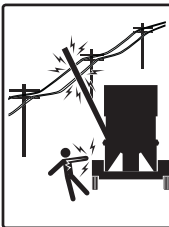

⚠ WARNING

ELECTROCUTION HAZARD

Avoid contact with overhead power lines or electrically powered objects.

- Be aware of your surroundings when raising or lowering any part of equipment.
- Maintain at least 20 feet between equipment and any electrical hazard.
- Contact with electricity can result in serious personal injury or death.

18433

7. Raise the auger tube by pushing it upward, using the delivery spout. A small gas-filled shock will assist in raising the auger tube.



110-055



110-026c

8. Lock the auger tube to the seed tender using the over-center clamp.

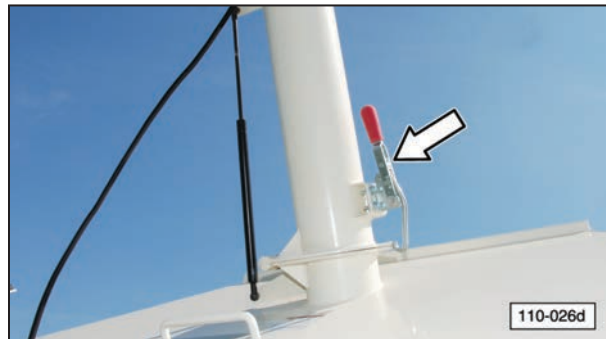

110-026d

⚠ CAUTION



PERSONAL INJURY HAZARD

Locking the clamp of the auger tube requires the operator to stand on the fender. Use caution and do not slip or fall when climbing on or off of the seed tender.

9. Place the delivery spout onto the delivery spout storage bracket.



110-026e

10. Press and hold the remote throttle switch to the right to move the throttle lever 1/3 the distance of the full open position. An electronic actuator is connected to the throttle lever to increase and decrease the speed of the engine.

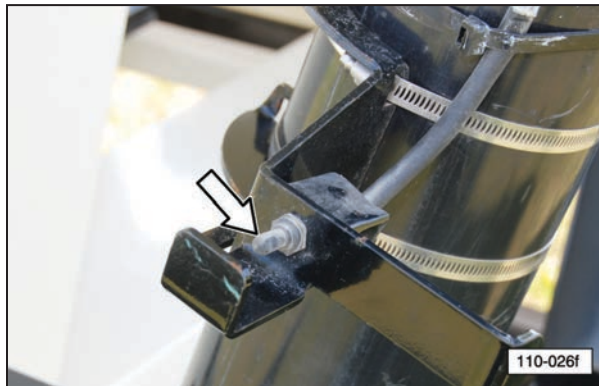

11. Start the gas engine.

- a. Move fuel valve lever (3) to the ON position.
- b. To start a cold engine, move choke lever (4) to the CLOSED position.

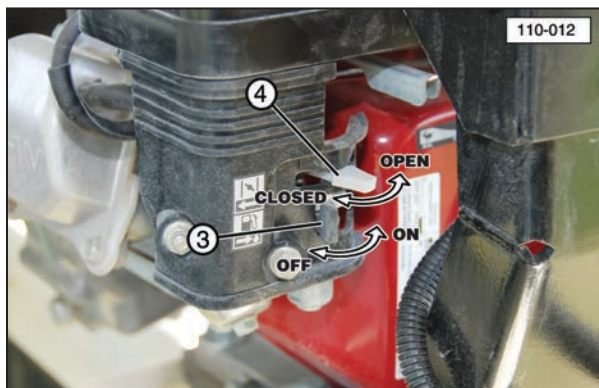

c. Turn the key switch to the START position.



12. If necessary, decrease the engine speed below 1400 RPM using the remote throttle control switch. A centrifugal clutch on the engine will engage and rotate the auger when the engine speed exceeds 1400 RPM. Increasing the engine speed will increase the unloading rate.



13. Open the seed slide gate by pushing the handle inward. Close the seed slide gate by pulling the handle outward.

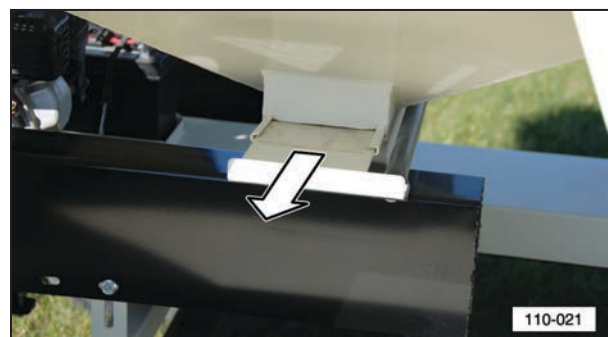

14. Fill the planting equipment.

- a. Move the delivery spout to the seed box or bin and increase engine RPM to rotate the auger.
- b. When the seed box or bin is full, reduce the engine RPM to low idle to stop the auger.
- c. Move the delivery spout to the next box or bin and increase engine RPM to fill the next one. Repeat this procedure until the remaining boxes or bins are filled.

15. When the transfer of seed is complete, press the auger speed control switch to reduce the engine RPM and stop the auger.

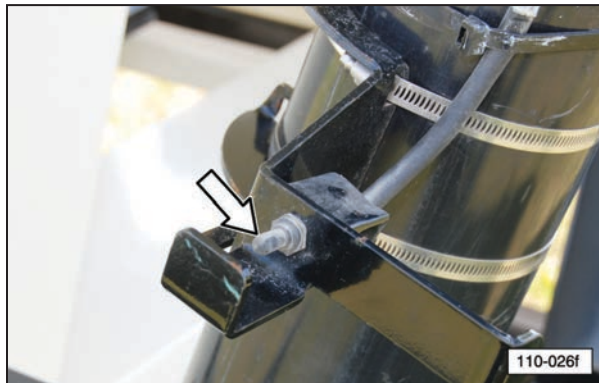

16. Close the seed bin slide gate by pulling the handle outward.

IMPORTANT

If the unit will not be used again for an extended period of time, the auger tube should be cleared of all seed. This will help prevent the seed from being clogged inside the tube.

17. Turn the gas engine off.

18. Place the engine's fuel lever in the OFF position before towing the seed tender on the open road.



19. Before towing the unit on the road, return the auger tube and delivery spout to its stored position. Latch the rubber tie-down strap over the delivery spout.

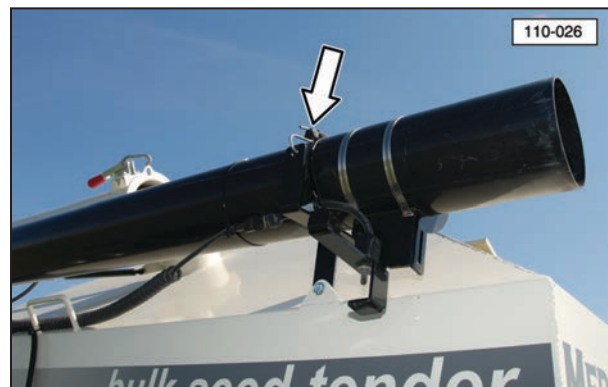

8.3.3 UNPLUGGING AUGER TUBE



If the auger tube plugs, follow this procedure.

1. Place the delivery spout on the storage bracket.
2. Stop the engine and remove the ignition key.
3. Open the access door at the bottom of the unloading auger tube.



4. Remove the obstruction.
5. Close and secure the access door.

9. STORAGE

9.1 STORAGE SAFETY

1. Store the unit in an area away from human activity.
2. Do not permit children to play on or around the stored machine.
3. Store the unit in a dry, level area. Support the frame with planks, if required.

9.2 GENERAL INFORMATION

After planting or when the machine will not be used for a period of time, completely inspect all major systems of the seed tender. Replace or repair any worn or damaged components to prevent unnecessary downtime at the beginning of the next season.

IMPORTANT

To prevent component damage, store the seed tender in a dry, level area. If the seed tender is not attached to a trailer, support the frame with planks to raise the unit off the ground.

9.3 PLACING IN STORAGE

CAUTION



PERSONAL INJURY HAZARD

Store the unit in an area away from human activity. To prevent the possibility of serious injury, do not permit children to play on or around the stored machine.

1. Remove all seed from the seed tender.
2. Place the gasoline engine fuel valve in the OFF position.
3. Thoroughly wash the machine with a pressure washer or water hose to remove all dirt, mud, or debris.
4. Inspect rotating parts for entangled material. Remove all entangled materials.
5. Check the condition of the auger and delivery spout. Replace or adjust, as required.
6. Check the condition of the centrifugal clutch reduction case, pulleys, idlers, and drive belt. Replace or adjust, as required.
7. Touch up paint nicks and scratches to prevent rusting.

8. Remove the ignition key and store in a secure place.
9. Remove the battery and store it in a cool, dry area on wooden blocks or a wooden pallet. Charge it monthly to maintain an adequate charge.
10. It is best to store the machine inside and if that is not possible, cover with a waterproof tarp and tie down securely.
11. Inspect, clean, and lubricate the auger tube hinge.
12. Cover the unit with a tarp, if desired.

9.4 REMOVING FROM STORAGE

When removing the machine from storage, follow this procedure:

1. Remove the tarp, if covered.
2. Install and connect the battery.
3. Review and follow the Pre-Operation Checklist.
4. Review and follow the Service Checks in the Maintenance section.









IMPORTANT



If the machine has been stored for more than twelve months, warm the engine by running it for two to three minutes and then drain the oil. Change the oil while the oil is warm to remove any condensation. Refer to the Change Engine and Reduction Case Oil section in the Maintenance section.

10. MAINTENANCE



10.1 SAFETY

10.1.1 General Safety

1. Good maintenance is your responsibility. Poor maintenance is an invitation for trouble.
2. Follow good shop practices. Keep service area clean and dry. Be sure electrical outlets and tools are properly grounded. Use adequate light.
3.  Ensure proper ventilation. Never operate the engine in a closed building. The exhaust fumes may cause asphyxiation.
4.  Before working on this machine, shut off the engine and remove the ignition keys.
5.  Never work under equipment unless it is securely blocked.
6. 
Always use personal protection devices, such as eye, hand, and hearing protectors, when performing any service or maintenance.
7.  Where replacement parts are necessary for periodic maintenance and servicing, genuine factory replacement parts must be used to restore your equipment to the original specifications. The manufacturer will not be responsible for injuries or damages caused by use of unapproved parts and/or accessories.
8.  A fire extinguisher and first aid kit should be readily accessible while performing maintenance on this equipment.
9.  Periodically tighten all bolts, nuts, and screws and ensure all cotter pins are properly installed to ensure the unit is in safe condition.
10.  When completing a maintenance or service function, make sure all safety shields and devices are installed before placing the unit in service.

11.  Turn OFF all electrical power and tag-out or lock-out the power source before performing any electrical test or before connecting or disconnecting valve coils or other electrical loads.
12.  Never operate or test any function of the equipment when people are in an area of a potential crush hazard.
13. Disconnect all electronic device cables from the seed tender before performing any arc welding repair. Damage from high currents may cause internal electronic device damage.

10.1.2 Lock-Out or Tag-Out Safety

1.  Establish a formal Lock-Out or Tag-Out program for your operation.
2.  Train all operators and service personnel before allowing them to work around the seed delivery system.
3.  Provide tags on the machine and a sign-up sheet to record tag-out details.

10.2 LUBRICATION

Use the Service Checks information in the Maintenance section to keep a record of all scheduled maintenance.

1. Use an SAE multi-purpose high temperature grease or a multi-purpose lithium base grease for the auger pivot hinge.
2. Use only a handheld grease gun for all greasing.
3. Wipe grease fitting with a clean cloth before greasing to avoid injecting dirt and grit.
4. Replace and repair broken zerks immediately.
5. If zerks will not take grease, remove and clean the passageway. Replace fitting, if necessary.

10.2.1 Wheel Bearings

Each axle is equipped with a grease zerk under the center dust cap of the wheel. Add grease sparingly to the wheel bearings, using only wheel bearing grease. The wheel bearings should be repacked annually. Check for excessive end play and tighten, if necessary.

IMPORTANT

Over greasing wheel bearings can cause them to overheat, resulting in damage and/or failure.



10.2.2 Auger Tube Pivot Shaft

Add grease to the pivot shaft hinge until it is forced out of the joints annually or as needed.

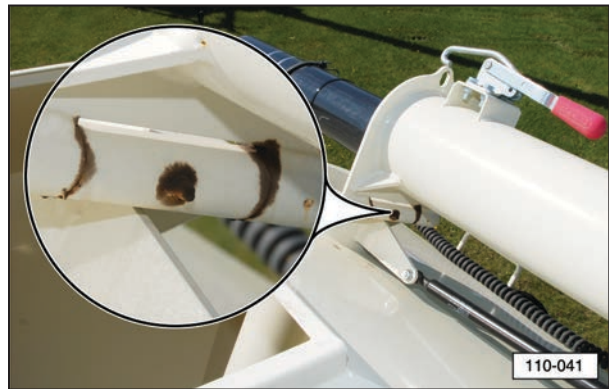

10.2.3 Seed Bin Cover

Remove any dirt or debris from the slide rails and lightly lubricate them, as needed.







10.3 BATTERY

Inspect the battery at least once every six months and before using the seed tender at the beginning of the season. Always follow the safety instructions when servicing a battery.



10.3.1 Battery Safety

-  Keep all sparks and flames away from batteries, as gas given off by electrolyte is explosive.
-  Avoid contact with battery electrolyte: wash off any spilled electrolyte immediately because battery acid can cause severe chemical burns.
-  Wear safety glasses when working near batteries.
- Do not tip batteries more than 45 degrees, to avoid electrolyte loss.
-  To avoid injury from spark or short circuit, disconnect the battery ground cable before servicing any part of the electrical system. Never short circuit the battery. It may explode.
-  Protect battery terminals, battery-charger terminals, and cables against accidental contact which can cause sparks, explosions, or component damage.
- Never attempt to jump start a frozen battery.

10.3.2 Battery Replacement and Maintenance Tips

- Check the batteries at least every six months for low Voltage, leakage, etc.
- Always use the correct size and type of battery. Replace old batteries with a new SP-30 Lawn and Garden battery with 230 CCA and 290 CA ratings.
- Do not install the battery cable to the wrong terminal. Make sure the RED cable is connected to the + (plus) terminal and the BLACK cable is connected to the – (minus) terminal.
- Remove the batteries from the seed tender if not expected to be in use for several months.
- Use recommended practices when recharging a dead battery.
- Remove any corrosion from the battery post using a wire brush terminal cleaner. Corrosion can also be removed using a baking soda paste and water to neutralize and remove the acid from the battery terminals
- Dispose of old batteries properly.

10.3.3 Battery Maintenance

- Make sure the tie-down strap is connected to the frame of the battery box and in good condition (not cracked, cut, or damaged).



- The battery is not charged when the engine is operating. If the battery is not charging using an external charger, check the fuse. Replace the fuse if necessary.

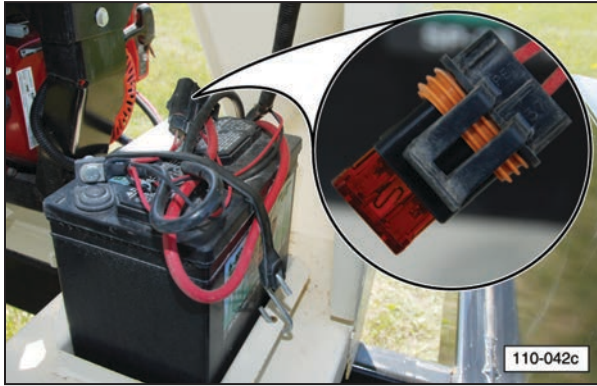





10.4 ENGINE

For any questions concerning the Honda® engine not provided in this manual, refer to the OEM manual that was provided with the seed tender.

To contact Honda®, refer to the OEM Literature section in this manual.

10.4.1 Refuelling Safety

-  Handle fuel with care. It is highly flammable.
-  Allow engine to cool for five minutes before refuelling. Clean up spilled fuel before restarting engine.
-  Do not refuel the machine while smoking or when near open flame or sparks.
- Fill fuel tank outdoors.
-  Prevent fires by keeping machine clean of accumulated trash, straw, grease, and debris.

10.4.2 Approved Fuel

Use unleaded automotive gasoline for all operating conditions. The fuel tank capacity is 3.6 liters (0.95 gals).

10.4.3 Engine Oil

Use a typical SAE 10W-30 or 10W-40 multi-viscosity motor oil for normal operating conditions. Consult your engine manual for the recommended oil in cold temperatures. The crankcase capacity is 0.60 liters (.63 US qts.).

10.4.4 Change Engine and Reduction Case Oil

- Review the Operator's Manual for the engine.
- Allow the engine to cool before changing the oil. Draining works best when the oil is warm.

CAUTION



BURN HAZARD
Hot engine oil can burn skin.

- Be sure the engine key switch is in the OFF position and the fuel valve is turned OFF.
- Place a pan under drain plug (1) or (2). Remove the drain plug and allow the oil to drain for ten minutes.

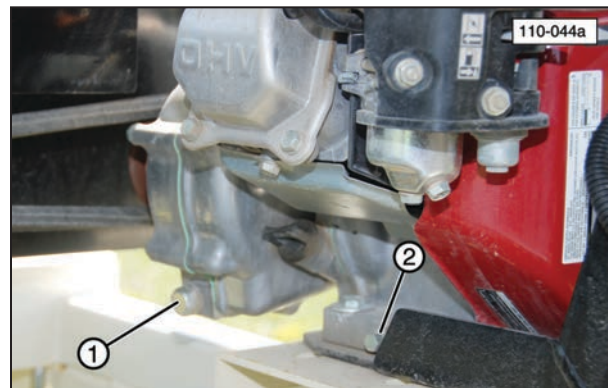

- Reinstall the drain plug and tighten.
- Dispose of the oil in an approved container. Follow industrial disposal regulations.
- Fill the engine or reduction case with SAE 10W-30 oil for general usage. If the engine is operated in more extreme conditions, refer to the OEM manual for oil recommendations.
- Run the engine for one minute and recheck both oil levels. Add oil, as needed.

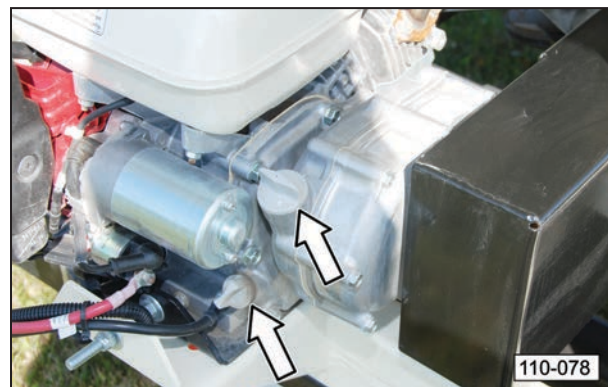

10.4.5 Clean Air Cleaner

Check and remove any debris from the foam cover of the air cleaner daily before each use. Thoroughly clean or replace the foam cover every three months or 50 hours of operation (clean it more frequently when used in dusty conditions).

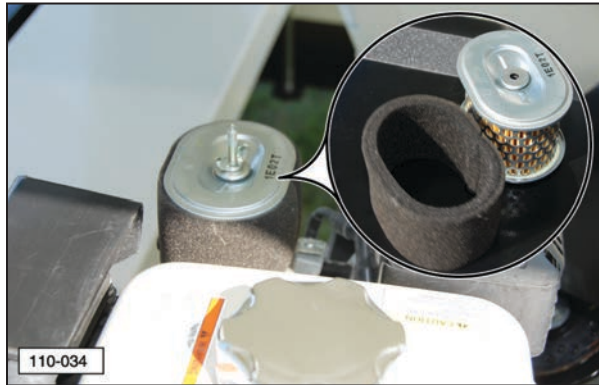

10.4.6 Engine Circuit Protection

The circuit protector protects the battery charging circuit. A short circuit, or a battery connected with reverse polarity, will trip the circuit breaker.

The green indicator inside the circuit protector will pop out to show that the circuit protector has switched off. If this occurs, determine the cause of the problem, and correct it before resetting the circuit protector.

Push the circuit protector button to reset.



10.5 ENGINE ACTUATOR REPLACEMENT

10.5.1 Actuator Removal

WARNING



CRUSHING HAZARD

Ensure the seed tender is blocked to prevent movement.

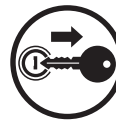

Ensure the engine is not running and remove the key during the following procedures. Serious injury or death can result from being caught in moving

parts.

1. Disconnect the actuator cable from the engine harness at connector (1).



2. Remove both bolts (2).



3. Loosen screw on wire holder, (3), and loosen screw on cable holder (4). Then remove the actuator cable from the holders.

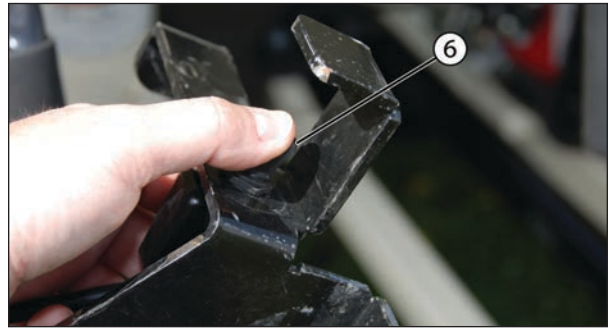

3. Ensure all personnel are clear of unit. Start the engine and test the actuator by pressing actuator switch (6) to ensure the engine speed increases and decreases as designed.

10.5.2 Actuator Installation

1. Connect the cable of the new actuator to engine harness connector (1).
2. Line up the cable end (5) with the cable/wire holders. Tighten screw on cable holder (4). Use actuator switch (6) on the delivery tube to position the wire. Once wire is positioned, tighten wire holder screw (3).



10.6 UNPLUGGING AUGER DELIVERY TUBE

IMPORTANT

Do not operate the auger when it is plugged with excess seed or is hindered from moving by a foreign object. Continued operation can cause damage.

If the auger becomes plugged, follow this procedure:

1. Stop the engine and remove the ignition key. Place a lock-out tag on the control box to prevent accidental starting of the conveyor.
2. Open the lower access door at the bottom of the auger and remove any excess seed or obstruction.



3. Close and secure the lower access door.

10.7 AUGER DRIVE BELT

The auger is driven by a belt from the motor. The belt is tightened by moving the engine base with the adjusting bolt.

10.7.1 Drive Belt Tension

Release the base when replacing the belt. Always install and secure the guard before resuming work.

1. Loosen the four engine mounting bolts.
2. Loosen the engine base stabilizing bolt.

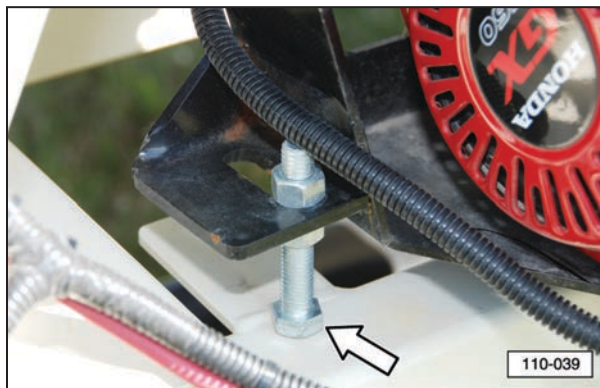

3. Loosen the engine base adjusting bolt jam nut and move the engine base to set the desired belt tension.

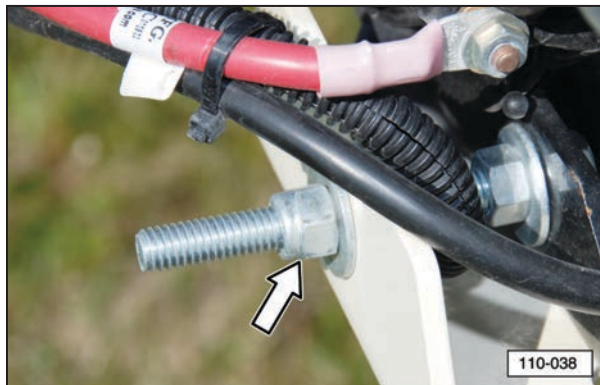

4. Tighten the jam nut.
5. Tighten the four engine mounting bolts.
6. Tighten the engine base stabilizing bolt.

10.7.2 Drive Belt Installation

Use the following photo for the correct routing of the drive belt. Always check the alignment of the pulleys when replacing the belt.



10.8 ENGINE SPEED SETTING

⚠ WARNING



ROTATING PART HAZARD

The engine speed must be adjusted with the engine running. Use extreme caution when working near rotating parts.



To prevent serious injury from rotating parts, do not operate with rotating parts exposed. Make sure the belt guard is installed before adjusting the engine speed.

Every engine is set with a high idle of 3000 RPM. Before using the seed tender, check the RPM of the auger drive pulley.

1. Start the engine. Use the throttle switch on the delivery tube to set the engine to high idle (full throttle).

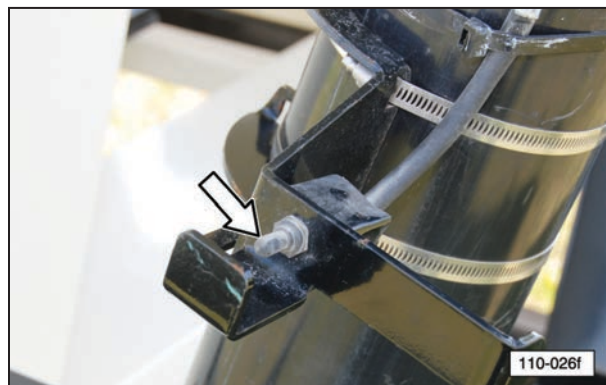

- Use a tachometer to check the large drive pulley speed. The pulley should turn 200 RPM at high engine speed.



- Use a screwdriver to reset the high idle stop screw if required to obtain the desired speed.

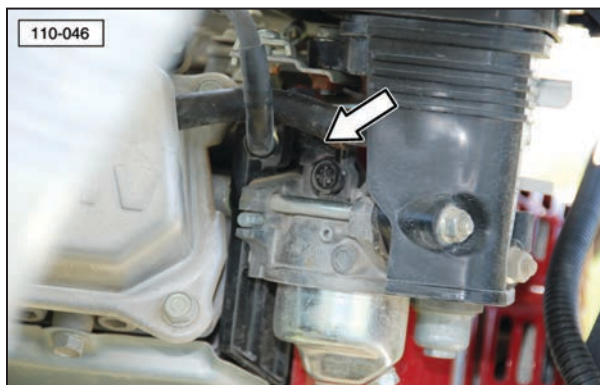

10.9 TRAILER BREAK-AWAY SYSTEM



10.9.1 Testing the Battery

- Disconnect the trailer plug from the tow vehicle; otherwise, you are testing the tow vehicle's battery.
- Press the green TEST button on the control box located inside the frame of the trailer. The green indicator light should illuminate if the battery is fully charged. If the yellow or red indicator lights illuminate, the unit's battery should be charged before towing the trailer.

IMPORTANT

If the battery is weak or dead (red indicator, even after charging), as indicated by the indicator light, the battery must be replaced.

- Plug the trailer into the tow vehicle. The yellow "Charging" light should be ON.
- Test the system by pulling the pin out of the break-away switch. The battery will activate the brakes. (**Note:** Do not use this kit as a parking brake). The battery should be charged and tested prior to each trailer outing.

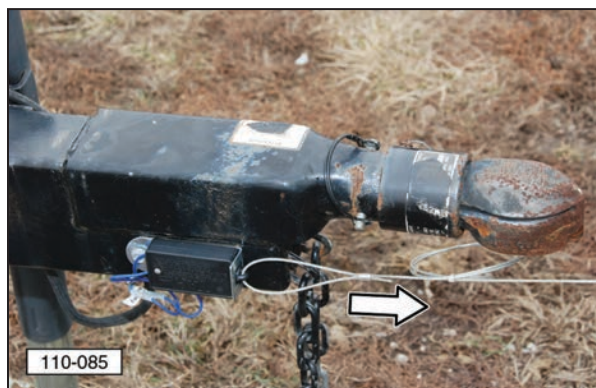

10.9.2 Changing Battery

The battery in the break-away system is rechargeable. If the battery will not hold a charge, replace the battery.

10.9.3 Replacing Battery

The battery in the break-away system is replaceable. If the battery will not hold a charge, replace the battery. Contact the OEM supplier for a replacement battery.

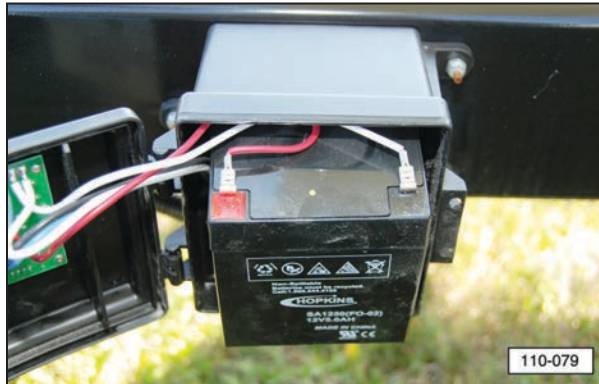

10.10 WHEEL BOLT TORQUE REQUIREMENTS



1. Initially check the wheel bolt torque at 10, 25, and 50 miles and after each wheel removal. Refer to the Wheel Bolt Torque Requirements section in this manual for tightening instructions.

NOTE: Torque wrenches are the best method to ensure the proper amount of torque is being applied to a wheel nut.

CAUTION



EXPLOSIVE FORCE HAZARD
To prevent injury due to possible dangerous separation of wheels from the axle, the wheel nuts must be maintained at the proper torque levels. Properly maintained wheel nuts prevent loose wheels and broken studs.

2. Tighten the wheel nuts in three stages.
 - First stage: 20 to 25 foot pounds.
 - Second stage: 50 to 60 foot pounds.
 - Third stage: 90 to 120 foot pounds.
3. Tighten the wheel nuts in a clockwise, cross-axle alternating pattern.

10.11 AXLE BOLTS AND FRAME HOLD-DOWN BOLTS

Check the torque on the axle/frame bolts at least once per year.

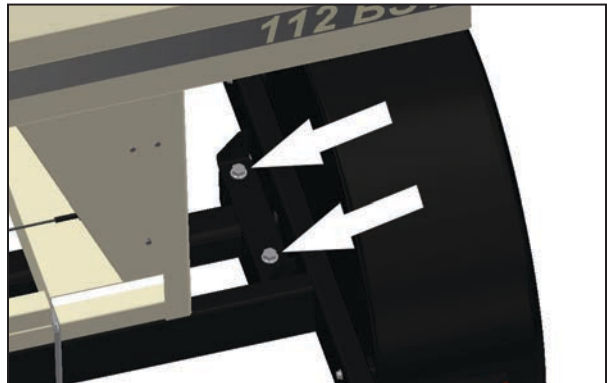

Check the torque on the frame hold-down bolts at least once per year. Tighten the bolts to 40 ft-lbs.



10.12 SERVICE RECORD CHART

The chart on the following page should be copied and filled out as maintenance is performed on the machine. Refer to the Lubrication, Maintenance, and Service sections for additional instructions.

Date																				
Serviced by																				
8 hours or daily																				
Check Engine Fluid Levels																				
Check Reduction Case Oil Level																				
Test Break-Away Brake System																				
Inspect Tires																				
Check Drive Belt Tension and Alignment																				
50 Hours or Weekly																				
Clean Engine Air Intake Filter																				
Check Tire Pressure																				
Check Drive Belt Tension and Alignment																				
200 Hours or Semi/Annual																				
Adjust Brakes																				
Inspect Brake Magnets																				
Battery - Make sure strap is securely holding battery onto frame, check electrolyte levels in the cells, and clean terminals to remove any dirt or corrosion.																				
400 hours or annually																				
Change Engine Oil																				
Change Reduction Case Oil																				
Check Wheel Bolt Torque																				
Check Frame Hold-Downs																				
Inspect Brake Lining Wear, Brake Cylinder, and Brake Wiring																				
Repack Wheel Bearings and Check Hub for Wear																				
Inspect Axle Grease Seal																				
Inspect Springs for Wear																				
Inspect all electrical wiring connections for looseness or corrosion. Tighten and/or seal, as necessary.																				
Thoroughly Clean Machine																				

10.13 SERVICE CHECKS

10.13.1 Daily (8 Hours)

WARNING



FIRE HAZARD

Gasoline is a highly combustible fuel. Improper use, handling, or storage of gasoline can be dangerous. Never touch or fill a hot engine. **DO NOT** fill the engine's fuel tank near an open flame while smoking or while engine is running. **DO NOT** fill tank in an enclosed area with poor ventilation. Wipe up spills immediately.

1. Check engine oil level (1) and fill, as needed.
2. Check engine fuel level and fill, as needed.
3. Check reduction case fluid level (2) and fill, as needed.

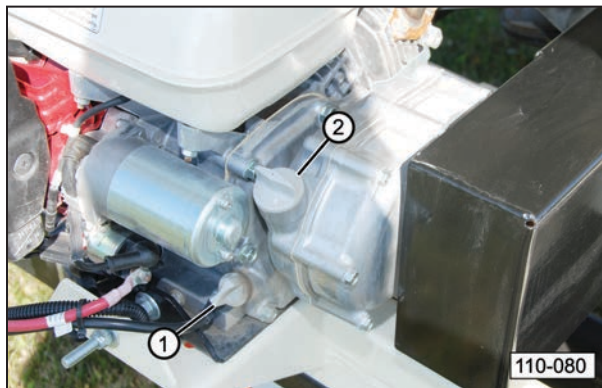

4. Test trailer break-away system.
5. Initially check wheel bolt torque at 10, 25, and 50 miles.
6. Check drive belt for proper tension and tracking.

10.13.2 Weekly (50 Hours)

1. Clean or replace the foam filter element. Replace the paper air filter, as required.

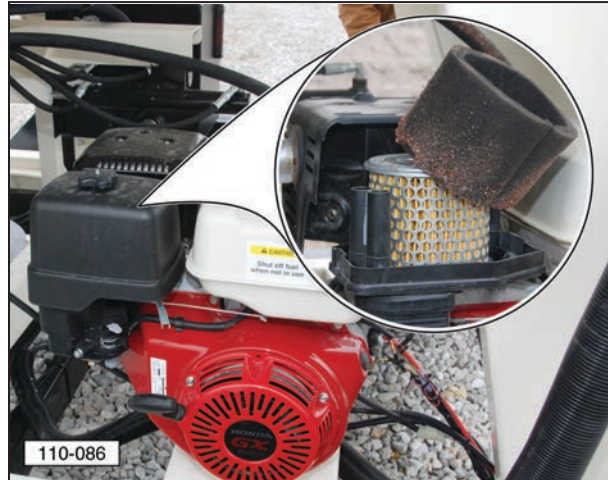

2. Check the tension on the delivery belt. Adjust tension if needed.
3. Check the tire pressure. Inflate the tires to the recommended pressure stated on the tire.

10.13.3 Annually (400 Hours)

1. Check wheel bolt torque.
2. Repack the wheel bearings and check for excessive end play in the bearings.
3. Check frame and trailer hold-down bolts.
4. Thoroughly clean the seed tender.
5. Check the tires for wear, and replace if needed.

10.14 AXLE MAINTENANCE

10.14.1 First 200 Miles

1. Adjust brakes. Refer to OEM manual for procedure.

10.14.2 3,000 Miles or 3 Months

1. Adjust brakes. Refer to OEM manual for procedure.
2. Check torque on wheel nuts. Refer to the section in this manual.
3. Inspect tires for wear. Refer to OEM manual for procedure.

10.14.3 6,000 Miles or 6 Months

1. Inspect brake magnets for wear. Refer to OEM manual for procedure.
2. Inspect suspension parts for wear. Refer to OEM manual for procedure.

10.14.4 12,000 Miles or 12 Months

1. Inspect brake lining wear, check brake cylinder for leaks, and inspect brake wiring for damage. Refer to OEM manual for procedure.
2. Grease the wheel bearings and check the hub for wear. Refer to OEM manual for procedure.
3. Inspect grease seal for leakage. Refer to OEM manual for procedure.
4. Inspect springs for any wear or loss of arch. Refer to OEM manual for procedure.

10.15 TIRES

Check the tires for normal and/or abnormal tire wear. Replace tires that are damaged or worn beyond normal tread life. Refer to the axle OEM manual for a Tire Wear Diagnostic Chart.

Replace the tires with Meridian part number 18131 or an equivalent tire:
3T235/80R16
TR643
Load Range E
For Trailer Service Only

10.16 WELDING REPAIRS



Repair welding must be done with care and with procedures that may be beyond the capabilities of the ordinary welder.

Before performing any type of welding repair to the seed tender, contact Meridian for approval.

WARNING



PERSONAL INJURY HAZARD

Repairs or modifications to the trailer, trailer tongue, or trailer hitch can result in serious injury or death should these repairs fail.

IMPORTANT NOTICE

Anyone performing a welding repair should be certified in accordance to the American Welding Society (AWS) standards.

11. OEM LITERATURE

OEM literature can be stored on the seed tender using the document storage tube.



11.2 AXLE

For any questions concerning the Dexter axle, refer to the OEM manual that was provided with the seed tender. An Owner's Manual and parts listing is provided with the seed tender.

Additional information can be obtained from:
 Dexter Axle Company.
 2900 Industrial Parkway East
 Elkhart, IN 46514
 Phone: (641) 357-3922

11.1 HONDA® ENGINE

For any questions concerning the Honda® engine, refer to the OEM manual that was provided with the seed tender.

INTRODUCTION

Thank you for purchasing a Honda engine. We want to help you to get the best results from your new engine and to operate it safely. This manual contains information on how to do that; please read it carefully before operating the engine. If a problem should arise, or if you have any questions about your engine, consult an authorized Honda servicing dealer.

All information in this publication is based on the latest product information available at the time of printing. Honda Motor Co., Ltd. reserves the right to make changes at any time without notice and without incurring any obligation. No part of this publication may be reproduced without written permission.

This manual should be considered a permanent part of the engine and should remain with the engine if resold.

Review the instructions provided with the equipment powered by this engine for any additional information regarding engine startup, shutdown, operation, adjustments or any special maintenance instructions.

United States, Puerto Rico, and U.S. Virgin Islands:
 We suggest you read the warranty policy to fully understand its coverage and your responsibilities of ownership. The warranty policy is a separate document that should have been given to you by your dealer.

SAFETY MESSAGES

Your safety and the safety of others are very important. We have provided important safety messages in this manual and on the engine. Please read these messages carefully.

A safety message alerts you to potential hazards that could hurt you or others. Each safety message is preceded by a safety alert symbol: **▲** and one of three words, DANGER, WARNING, or CAUTION.

These signal words mean:

- ▲ DANGER** You WILL be KILLED or SERIOUSLY HURT if you don't follow instructions.
- ▲ WARNING** You CAN be KILLED or SERIOUSLY HURT if you don't follow instructions.
- ▲ CAUTION** You CAN be HURT if you don't follow instructions.

Each message tells you what the hazard is, what can happen, and what you can do to avoid or reduce injury.

DAMAGE PREVENTION MESSAGES

You will also see other important messages that are preceded by the word NOTICE.

This word means:

NOTICE Your engine or other property can be damaged if you don't follow instructions.

The purpose of these messages is to help prevent damage to your engine, other property, or the environment.

© 2005 Honda Motor Co., Ltd. - All Rights Reserved
 372AF603
 003X3-ZAF-6030

HONDA

OWNER'S MANUAL
MANUEL DE L'UTILISATEUR
MANUAL DEL PROPIETARIO

GX120 · GX160 · GX200



Click here to save this manual to your computer.

WARNING:
 The engine exhaust from this product contains chemicals known to the State of California to cause cancer, birth defects or other reproductive harm.

CONTENTS

INTRODUCTION.....1	SEDIMENT CUP.....12
SAFETY MESSAGES.....2	SPARK PLUG.....12
SAFETY INFORMATION.....3	SPARK ARRESTER.....13
SAFETY LABEL LOCATION.....2	IDLE SPEED.....13
COMPONENT & CONTROL LOCATION.....3	HELPFUL TIPS & SUGGESTIONS.....13
FEATURES.....3	STORING YOUR ENGINE.....13
BEFORE OPERATION CHECKS.....4	TRANSPORTING.....14
OPERATION.....4	TAKING CARE OF UNEXPECTED PROBLEMS.....15
SAFE OPERATING PRECAUTIONS.....4	FUSE REPLACEMENT.....15
STARTING THE ENGINE.....4	TECHNICAL & CONSUMER INFORMATION.....16
STOPPING THE ENGINE.....5	Serial Number Location.....16
SETTING ENGINE SPEED.....6	Battery Connections for Electric Starter.....16
SHUTTING YOUR ENGINE.....7	Remote Control Linkage.....16
THE IMPORTANCE OF MAINTENANCE.....7	Carburetor Modifications for High Altitude Operation.....16
MAINTENANCE SAFETY.....7	Oxygenated Fuels.....17
SAFETY PRECAUTIONS.....7	Emission Control System Information.....17
MAINTENANCE SCHEDULE.....7	Air Index.....18
REFUELING.....8	Specifications.....18
ENGINE OIL.....8	Tuneup Specifications.....18
Recommended Oil.....8	Quick Reference Information.....19
Oil Level Check.....9	Wiring Diagrams.....19
REDUCTION CASE OIL.....9	Information.....20
Recommended Oil.....9	CONSUMER INFORMATION.....20
Oil Level Check.....9	Distributor/Dealer Locator.....20
Oil Change.....10	Information.....20
AIR CLEANER.....10	Customer Service Information.....20
Inspection.....10	
Cleaning.....11	

Additional information can be obtained from:

United States Power Equipment Division
 Customer Relations Office
 4900 Marconi Drive
 Alpharetta, GA 30005-8847
 (770) 497-6400

Honda® Canada, Inc.
 715 Milner Avenue
 Toronto, ON M1B 2K8
 (888) 946-6329

12. TROUBLESHOOTING

12.1 TROUBLESHOOTING CHART

PROBLEM	CAUSE	SOLUTION
Engine will not start.	No fuel.	Fill the fuel tank.
	Low engine oil.	Fill the crankcase with oil.
	Cold engine.	Open choke.
	Ignition key switch off.	Turn ignition key switch on.
	Battery dead.	Recharge or replace battery.
	Engine problem.	Refer to engine manual.
Auger will not start.	Not rotating.	Start engine and increase speed above 1400 RPM.
	Drive pulley connection or auger coupling.	Repair or replace.
	Drive belt slipping.	Increase belt tension.
	No hydraulic oil in reduction case.	Check oil level.
	Failed centrifugal clutch.	Replace clutch.
Electrical functions are not working properly.	Battery cable or battery.	Check battery cable and make sure battery is fully charged.
	Improper ground.	Check for proper grounding of electrical circuit.
Remote throttle doesn't work.	No input power.	Check charge of battery. Recharge or replace, as required.
		Check connections in the remote throttle harness. Be sure connectors are clean and terminals are firmly pushed together.

13. WARRANTY

13.1 WARRANTY STATEMENT

Limited Materials and Workmanship Warranty For Bulk Seed Tenders

Meridian Manufacturing Group (hereinafter referred to as the Manufacturer) hereby warrants the Bulk Seed Tender(s) sold by it to be free from any defect in material or workmanship under normal use and service for a period of one (1) year from the date of shipment. The Manufacturer's obligation under this warranty shall be limited to the repair or replacement only, FOB the original point of shipment, of any defective parts or portions of the seed tender or accessories manufactured by Meridian. Any warranty claim must be reported to the Manufacturer within one (1) year from the date of shipment.

THIS WARRANTY IS SUBJECT TO THE FOLLOWING LIMITATIONS, PROVISIONS AND CONDITIONS:

1. This warranty does not apply:
 - a) To any product sold by the Manufacturer where it is used in areas exposed to corrosive or aggressive conditions including salt water, acids, alkaloid, ash, cement dust, animal waste or other corrosive chemicals from either inside or outside the bin.
 - b) For failures or defects arising out of damage during shipment or during storage on site.
 - c) To materials replaced or repaired under this warranty except to the extent of the remainder of the applicable warranty.
 - d) To damage resulting from misuse, negligence, accident or improper site preparation by others.
 - e) If the product has been altered or modified by others.
 - f) If in the case of coating failures the failure is the result of damage, lack of proper maintenance or failure to remove road salt or other contaminants that may have come in contact with the bin surface.
 - g) To loss of time, inconvenience, loss of material, down time or any other consequential damage.
 - h) For a function that is different than original designed intent.
2. The obligation of the Manufacturer under this warranty shall not arise unless the Manufacturer is notified and this warranty is presented together with a written statement specifying the claim or defect within thirty (30) days after the failure is first detected or made known to the owner and within one (1) year from the shipment date. The Manufacturer in its sole discretion shall determine if the claim is valid and whether correction of the defect or failure shall be made by repair or replacement of the materials.
3. The coating warranty is based on the manufacturer's performance specification for Polyester Powder finishes and does not include repair of minor blemishes or rusting that is normally part of the general maintenance of the seed tender. This warranty does not cover excessive wear on interior coatings. See attachment for full Performance Specification details on Polyester Powder Finishes.
4. The obligation of the Manufacturer hereunder extends only to the original owner and to the Meridian dealer to whom the materials may have been initially sold. This warranty shall not be subject to any assignment or transfer without the written consent of the Manufacturer.
5. The customer shall acknowledge that it has made its own independent decision to approve the use of the supplied materials and also the specific fabrication and construction procedures utilized to complete the seed tender, and has satisfied itself as to the suitability of these products for this particular application.
6. The foregoing sets forth the only warranties applicable to said materials and said warranties are given expressly and in lieu of all other warranties, expressed or implied, statutory or otherwise, of merchantability or fitness for a particular purpose and all warranties which exceed or differ from said warranties herein are disclaimed by the Manufacturer.
7. The owners sole and exclusive remedy against the Manufacturer shall be limited to the applicable warranty set forth herein and the endorsements, if any, issued together with this document and no other remedy (including but not limited to the recovery of assembly or disassembly costs, shipping costs, direct, incidental, special, indirect or consequential damages for lost profits, lost sales, injury to person or property or any other loss, whether arising from breach of contract, breach of warranty, tort, including negligence, strict liability or otherwise) shall be available to the owner or Meridian Dealer or any other person or entities whether by direct action or for contribution or indemnity or otherwise.
8. The financial obligation of the Manufacturer under this warranty shall be limited to the repair or replacement of the product as originally supplied and in no event shall exceed the original cost of the product supplied.
9. The Manufacturer shall not have any obligation under any warranty herein until all accounts for materials, installation and erection of the said product thereof and for labor and other work performed by the Manufacturer or its dealers have been paid in full by the owner.

Warranty Claim Procedure

1. Registering product with Meridian Manufacturing.
2. Contact the dealer unit was purchased from upon discovery of any defects.
3. A completed warranty claim form submitted by dealer to Meridian warranty representative for review and course of action.
4. Warranty repair work will only be performed by Meridian, the dealer or an approved representative. No warranty work completed prior to approval. Failure to follow procedure may affect any or all reimbursement.
5. Claims will be adjudicated at the sole discretion of the manufacturer and in accordance with the terms and conditions of the applicable limited warranty.
6. A complete list of warranty procedures can be procured from the Warranty Department or found in your owner's manual.

Effective July 1, 2009

14. PARTS

The following pages contain a list of serviceable parts for the 112BST Seed Tender unit.

Parts are available from your authorized Dealer Parts Department.

14.1 112BST SEED TENDER

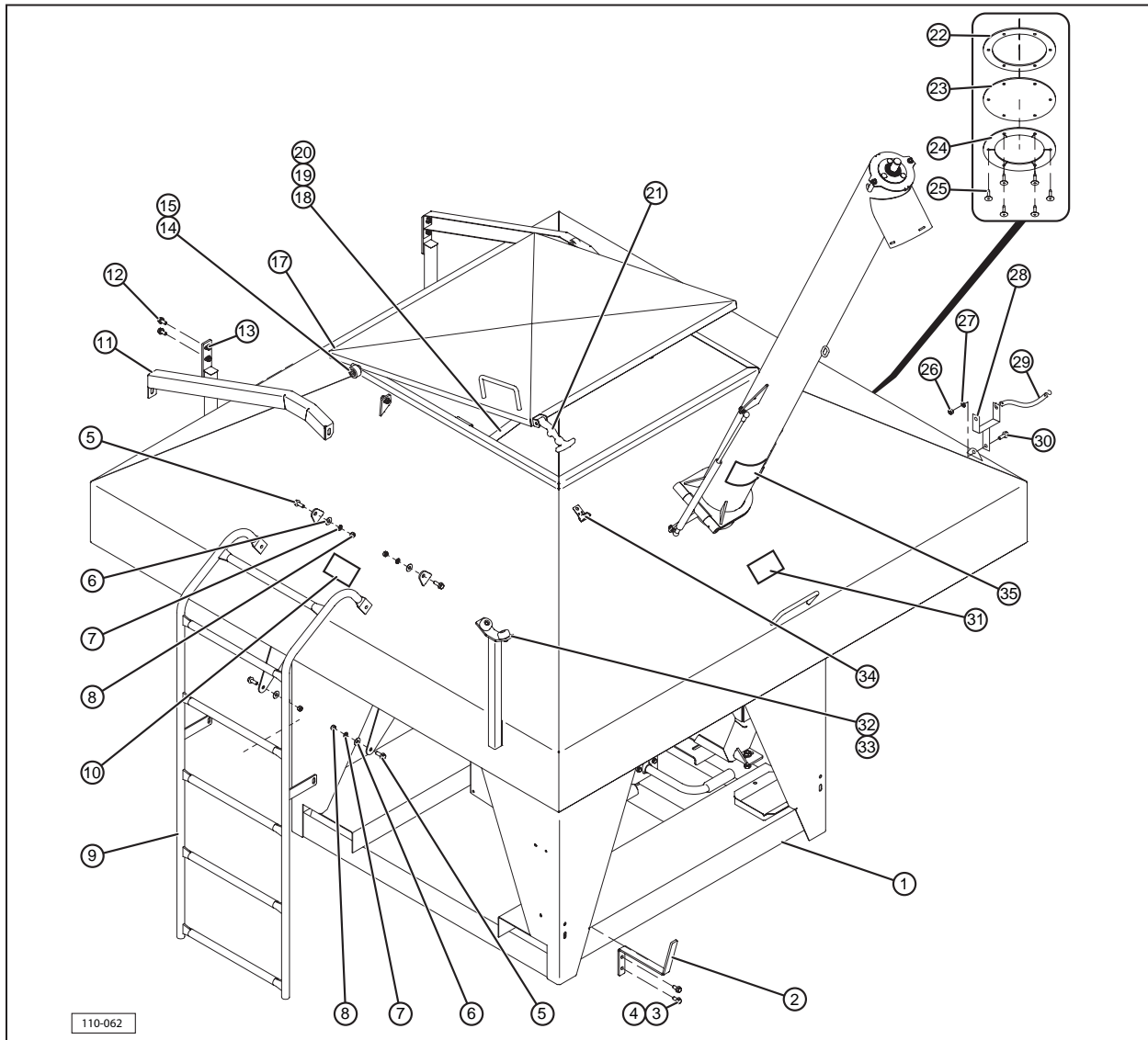

1	1	35504-00	Base Assembly
2	1	21036-00	Bracket, Flex Spout Hanger
3	2	19564	Nut, Hex, Flange, 3/8-16
4	2	19577	Bolt, Hex, Flange, 3/8-16 x 3/4"
5	1	19569	Bolt, Hex, Flange, 3/8-16 x 1"
6	1	19348	Washer, Flat, 3/8"
7	4	19349	Washer, Lock, 3/8"
8	1	19343	Nut, Hex, 3/8-16
9	1	35503-00	Ladder Assembly
10	1	19939	Decal, Warning, Fall Hazard
11	1	35509-01	Track, Lid Assembly
12	2	19569	Bolt, Hex, Flange, 3/8-16 x 1"
13	2	19564	Nut, Hex, Flanged, 3/8-16
14	1	19401	Roller, Nylon Sleeve
15	1	19402	Roller Inner Bushing
17	1	35502-00	Lid, Hopper Assembly
18	1	35505-00	Arm, Swing Assembly

19	2	19325	Bolt, Hex, 3/8-16 x 1"
20	2	19347	Nut, Lock, 3/8-16 Nylon
21	1	18111	Latch, Rubber
22	1	19055	Gasket, View Glass
23	1	19285	Glass, Lexan View
24	1	19077	Ring, View Glass
25	6	19129	Rivet, 3/16"
26	1	19564	Nut, Hex, Flange, 3/8-16
28	1	30995	Bracket, Spout Rest
29	1	21319-00	Strap, Tarp 6"
30	1	19569	Bolt, Hex, Flange, 3/8-16 x 1"
31	1	19935	Decal, Warning, Pinch Point
32	2	19133	Bumper, Rubber
33	2	19301	Bolt, Hex, 1/4-20 x 1"
34	1	18112	Anchor for Latch
35	1	17509	Decal, Warning, Electrocution

14.2 112BST SEED TENDER FRAME

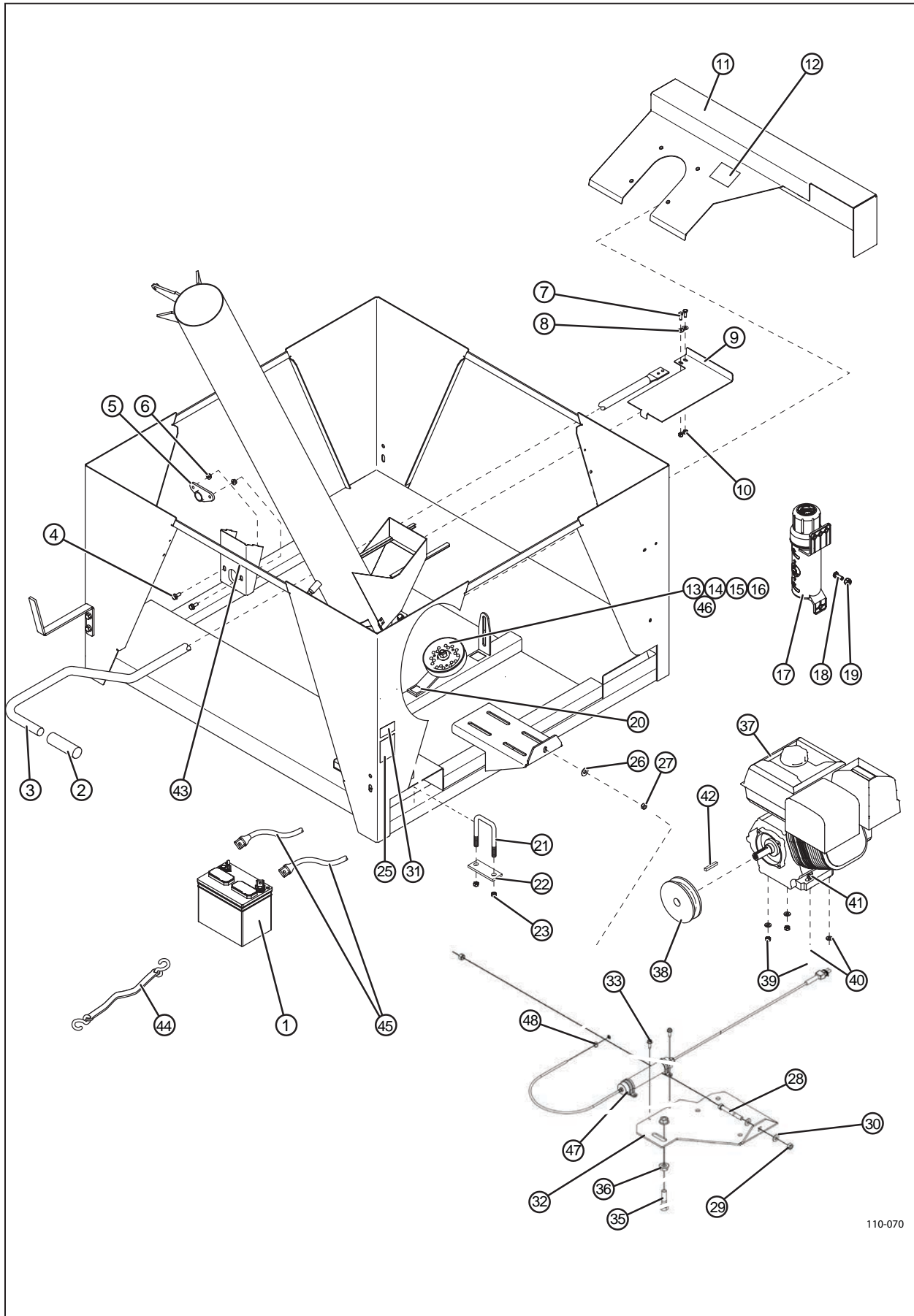

110-070

1	1	21286-00	Battery, SP30
2	1	19447	Handle Grip
3	1	21065-00	Slide Gate Handle
4	2	19568	Bolt, 5/16-18 X 3/4" Flanged
5	1	19404	Bushing, Nylon 1"
6	2	19318	Nut, Hex, 5/16-18 Flanged
7	2	19560	Bolt, Hex, 1/4-20 X 3/4"
8	2	19307	Washer, 1/4"
9	1	21063-00	Gate, Slide
10	2	19128	Nut, Hex, 1/4-20 Nylon
11	1	36035-00	Guard, Belt
12	1	19937	Decal, Warning, Rotating Part Hazard
13	1	21253-00	Pulley, Idler, 5"
14	3	19372	Washer, 1/2"
15	1	19127	Nut, Lock, 1/2-13 Nylon
16	1	19356	Bolt, Hex, 1/2-13 x 2
17	1	18128	Holder, Manual
18	3	19560	Bolt, Hex, 1/4-20 UNC x 3/4" HHCS
19	3	19128	Nut, Hex, 1/4-20 UNC, Nylon
20	1	18435-00	Decal, Danger, Entanglement Hazard
21	4	19121	U-Bolt, 1/2-13 x 3-1/8 x 8"
22	4	21278-04	Strap, Tie Down
23	8	19595	Nut, Flanged, 1/2-13
25	1	19934	Decal, Caution, Read The Manual
26	1	19348	Washer, Flat, 3/8"
27	1	19347	Nut, Lock, 3/8-16 Nylon
28	1	19330	Bolt, Hex, 3/8-16 x 3" Full Thread
29	1	19343	Nut, Hex, 3/8-16
30	2	19348	Washer, Flat, 3/8"
31	1	—	Decal, Serial Number
32	1	38511-00	Bracket, Actuator Assembly
33	2	19597	1/4" -14 x 3/4" Self Drilling Screw
35	1	19356	Bolt, Hex, 1/2-13 UNC x 2
36	1	19595	1/2"-13 Fanged Nut
37	1	21255	Motor, Honda 5.5 Hp Electric Start
38	1	21251-00	Pulley, 3" Honda Drive
39	4	19347	Nut, Lock, 3/8-16 Nylon
40	4	19348	Washer, Flat, 3/8"
41	4	19626	Bolt, Hex, Flanged, 3/8-16 x 1-3/4"
42	1	21261	Key, Square
44	1	21319-00	Strap, Rubber, Battery Hold Down
45	1	18657	Cable, Battery
46	1	21247-00	Bracket, Idler Pulley
47	1	17721	Actuator w/ Cable & Clamps
48	1	21270-00	Throttle Cable Wire Holder

14.3 112BST UPPER AUGER TUBE

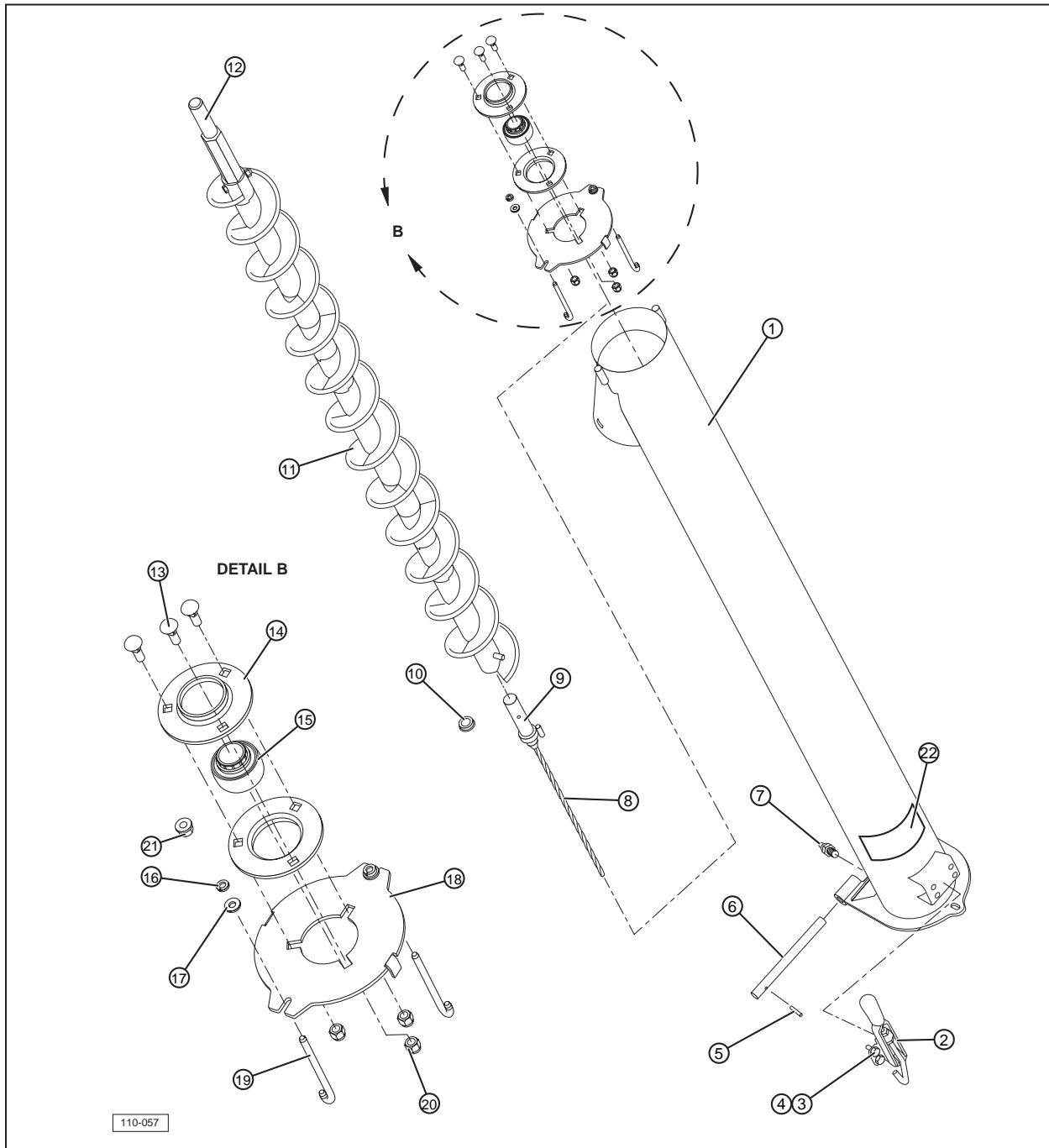

110-057

1	1	36003	Tube, Fold Over Auger Assembly
2	1	19123	Latch, Fold Over Auger
3	4	19309	Bolt, Hex, 5/16-18 x 3/4"
4	4	19318	Nut, Hex, Flanged, 5/6-18
5	1	19284	Pin, Spring, 3/16" x 1-1/8"
6	1	21223-00	Pin, Hinge
7	1	19283	Zerk, Grease
8	1	21445-00	Cable, Auger Alignment
9	1	21333-02	Shaft, Top Auger Bottom Drive
10	1	19405	Bushing
11	1	18714	Auger, Top Assembly

12	1	21453-00	Shaft, Auger Tail
13	1	19315	Bolt, Carriage, 5/16-18 x 3/4"
14	2	21259-00	Flange, Bearing 52 mm Zinc
15	1	21258-00	Bearing
16	2	19308	Washer, Lock, 1/4"
17	2	19307	Washer, Flat, 1/4"
18	1	21222-03	Cap, 6" Top Bearing
19	2	19582	J-Bolt, 1/4-20 x 1-1/2"
20	3	19586	Nut, Lock, 5/16-18 Nylon
21	2	19305	Nut, Hex, 1/4-20
22	1	17509	Decal, Danger, Electrocution

14.4 112BST LOWER AUGER TUBE

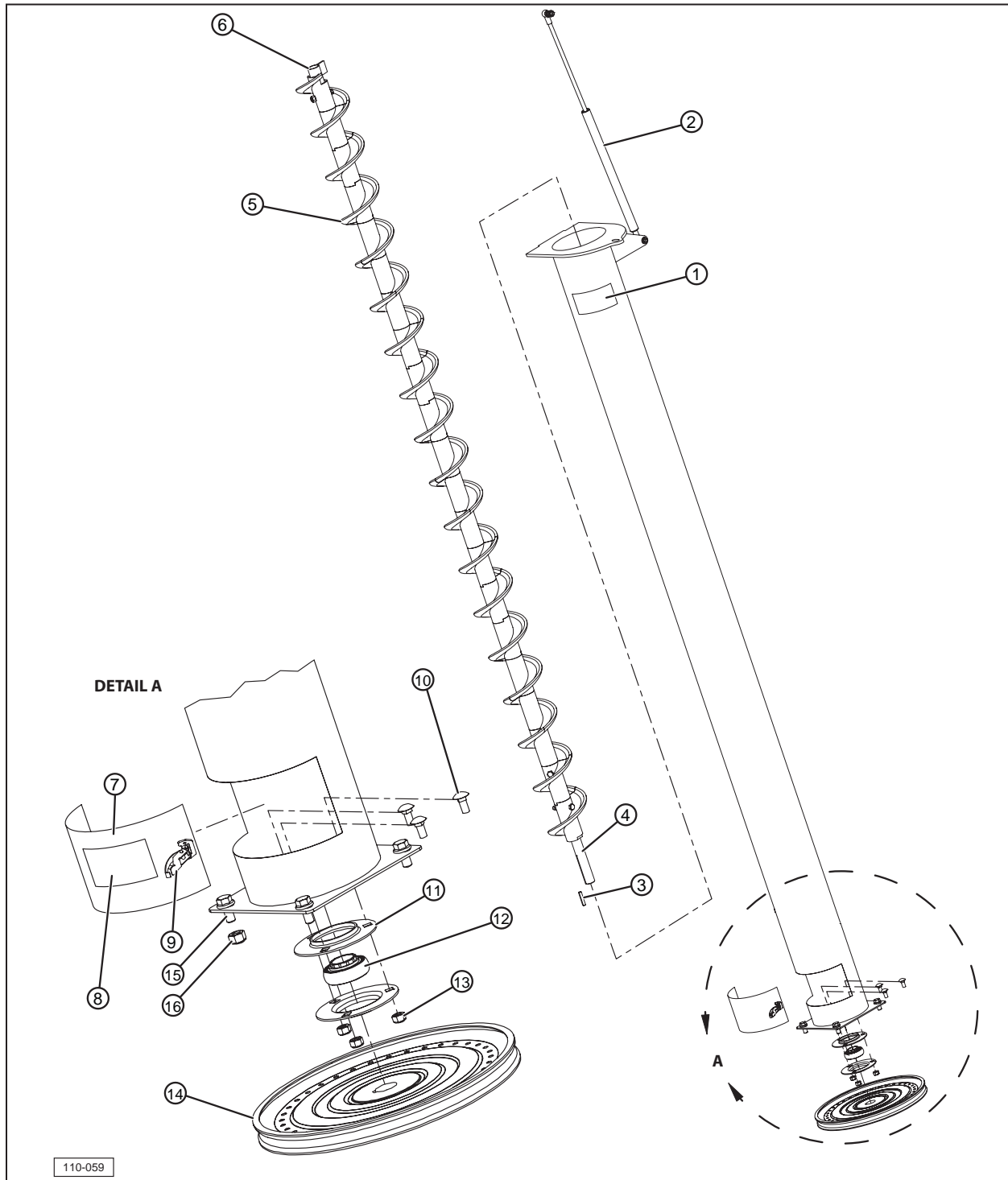

110-059

1	1	19935	Decal, Warning, Pinch Point
2	1	21407-00	Shock, Lift Assist (250 lb Capacity)
3	1	21261-00	Key, Drive
4	1	21452-00	Shaft, Bottom Auger Drive
5	1	18713	Auger, Bottom Assembly
6	1	18713	Flighting, Bottom Auger Assembly
7	1	36504	Door, Clean Out
8	1	19936	Decal, Warning, Entanglement Hazard

9	1	21257-00	Latch Assembly
10	3	19315	Bolt, Carriage, 5/16-18 x 3/4"
11	2	21259-00	Flange, Bearing 52 mm Zinc
12	1	21258-00	Bearing
13	3	19586	Nut, Lock, 5/16-18 Nylon
14	1	21323-00	Pulley, 12"
15	4	19309	Bolt, Hex, 5/16-18 x 3/4"
16	4	19318	Nut, Flanged, 5/16-18

14.5 112BST THREE TIER SPOUT

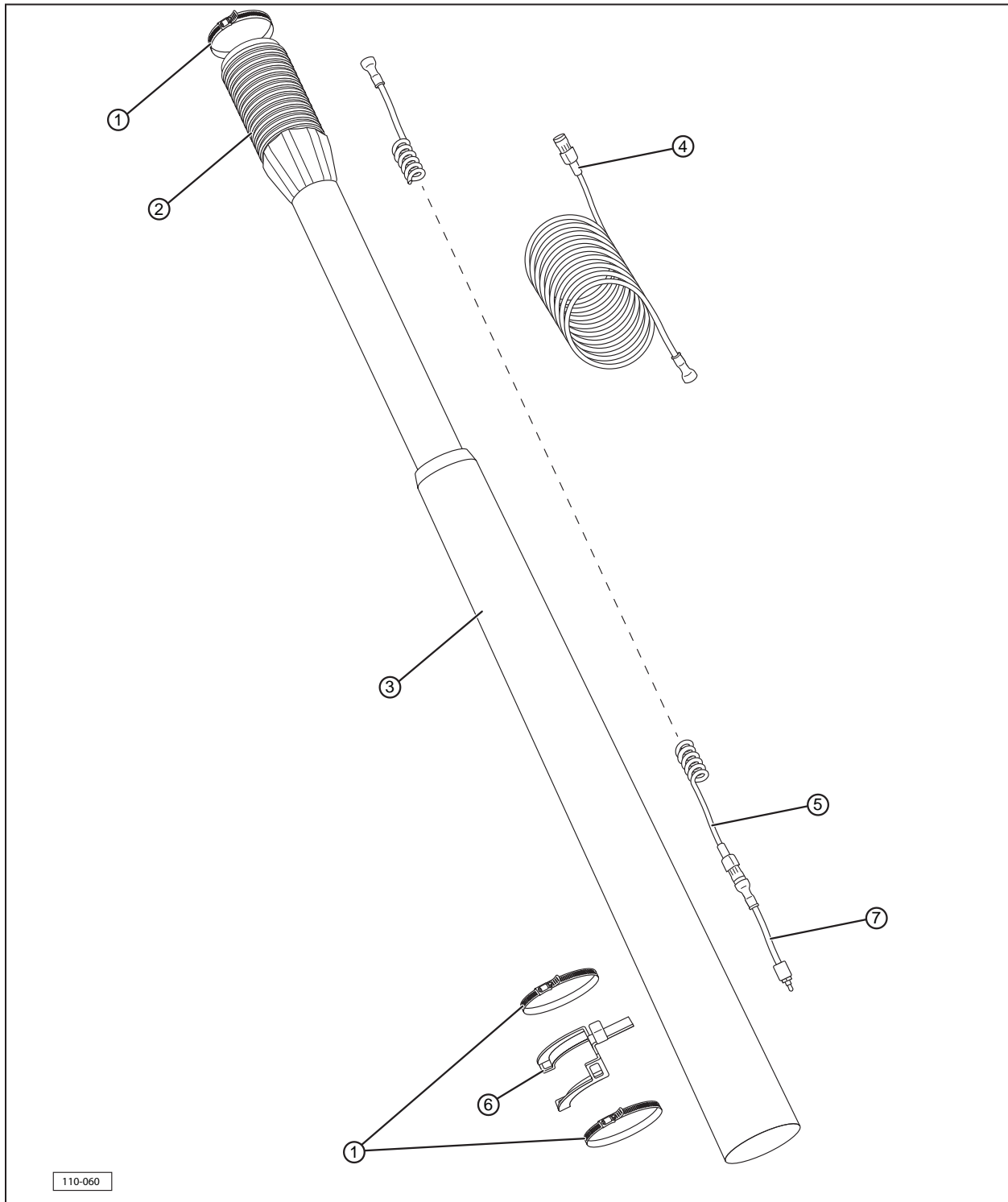

1	3	21433-00	Clamp, Hose, 6"
2	1	34753	6" Flex Hose w/ Clamp
3	1	38530-00	Spout, Three-Tier
4	1	36106-00	Harness, Wire (to engine/battery)
5	1	38503-01	Cord, Coiled
6	1	21240-04	Throttle Handle
7	1	14002	Harness, Wire, Pigtail with Switch

14.6 112BST TRAILER

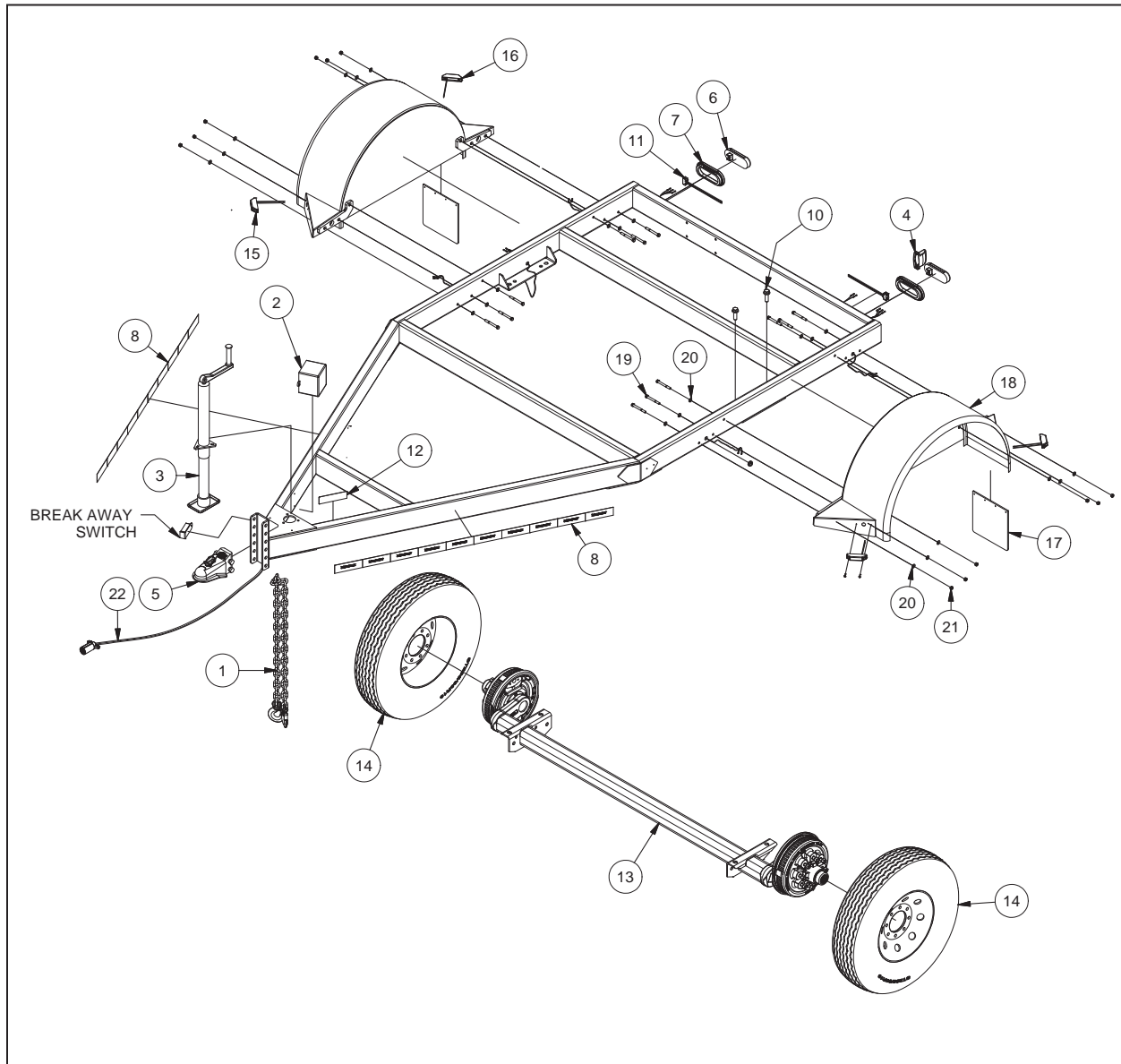

1	2	19171	3/8" x 35" , GRADE 70 CHAIN
2	1	19275	Battery Breakaway BA10-150
3	1	18192	TOP WIND A-FRAME JACK
4	1	17674	LIGHT, LICENSE PLATE,
5	1	24688	COUPLER HITCH ASSM. 2 5/16"
6	2	17670	TAIL LIGHT LED OVAL RED
7	2	17671	GROMMET TAIL LIGHT
8	10	18096	Tape Reflective Meridian
10	4	19567	BOLT, FLANGED,5/8-11 UNC x 2
11	2	10045	PLUG, S/T/T, 11"
12	1	-----	DECAL, TRAILER VIN#
13	1	18193	Axle, 7,000 lbs
14	2	18131	Tire, ST235/80R16
15	2	17668	YEL CLEARANCE LIGHT LED
16	2	17669	RED CLEARANCE LIGHT LED

17	2	19274	MUD FLAP
18	2	40618	FENDER, PAINTED, 112 TRAILER
19	12	19331	BOLT, HEX, 3/8-16 UNC X3.5
20	24	19348	WASHER, FLAT 3/8
21	12	19347	Ø3/8"-16 UNC NYLON LOCKNUT
22	1	10469	WIRE HARNESS, 112 BST

NOTES

NOTES

NOTES

MERIDIAN MANUFACTURING INC.
With over 65 years of experience,
Meridian is your storage and handling expert.



www.meridianmfg.com

Cambridge Office
605 Sheldon Dr.
Cambridge, On. N1T 2K1
PH: 519.620.6004
TF: 855.346.3712
FX: 519.620.6041

Camrose Office
4232 - 38 St.
Camrose, AB T4V 4B2
PH: 780.672.4516
TF: 800.830.2467
FX: 780.672.4759

Lethbridge Office
3125 - 24 Ave. N.
Lethbridge, AB T1H 5G2
PH: 403.320.7070
TF: 800.661.1436
FX: 403.320.7579

Regina Office
PO Box 1996
Regina, SK S4P 3E1
PH: 306.545.4044
TF: 800.667.5904
FX: 306.545.4216

Storm Lake Office
2902 Expansion Blvd.
Storm Lake, IA 50588
PH: 712.732.1780
TF: 800.437.2334
FX: 712.732.1028

Winkler Office
Box 760, 275 Hespler Ave.
Winkler, MB R6W 4A8
PH: 204.325.7883
TF: 800.665.7259
FX: 204.325.5556