

MERIDIAN[®]

BULK SEED TENDER[®]

240 RT SEED EXPRESS[™] • 375 RT SEED EXPRESS[™]



meridianmfg.com/Seed-Express



OPERATOR'S MANUAL

PRODUCT REGISTRATION FORM



Attention Dealers:

You can register products online through the Dealer Login: <http://dealers.meridianmfg.com/login/>

It is mandatory to register your product in order to qualify for future warranty claims that may arise. Knowingly falsifying information on this form will result in the voiding of the product warranty.

You may scan/photograph this completed form (must be legible), email it to: register@meridianmfg.com

A copy of this form may be mailed to Meridian Manufacturing Inc. 2902 Expansion Blvd. Storm Lake, IA 50588

Buyer's Name _____ Dealer's Name _____

Address _____ Address _____

City, State/Prov _____ City, State/Prov _____

Zip/Postal Code _____ Zip/Postal Code _____

Phone Number _____ Phone Number _____

Note: Registering a product in multiple entry format is only allowed when the product has the same model number and the same dealer, however each serial number must be legibly listed for each unit. Delivery dates for a multiple entry must be within a one month time frame.

Product Information _____

Model Number _____ Serial Number _____

Invoice Date _____

Important: Please send this form to the Meridian Manufacturing Inc. location which built this product being registered. If you require further assistance call you're dealer or the Meridian outlet nearest to your location.

We want to thank you for purchasing a Meridian manufactured product. Whether this is your first Meridian purchase or you have been a customer for years, you are now part of the Meridian community of customers and we appreciate your business.

It is important that you now complete the product registration information and this form indicating you have received delivery. This registration and information is necessary to ensure you have access to warranty and product updates in the event it be required in the future.

Registration can be completed by using this form or visiting your dealer who will complete the form online. You will be given access to the Meridian Community and become eligible for updates, special offers and prizes.

Again, thank you for choosing Meridian.

I have thoroughly instructed the buyer on the above described equipment. The review included the content of this manual, equipment care, adjustments, safe operation and warranty policy.

Date _____ Dealer's Signature _____

The above equipment and this manual have been received by me. I have been thoroughly instructed as to care, adjustments, safe operation and applicable warranty policy.

Date _____ Buyer's Signature _____

DEALER INSPECTION REPORT



MERIDIAN MANUFACTURING INC.
2902 EXPANSION BLVD. STORM LAKE, IA 50588
T: (800) 437-2334 P: (712) 732-1780 F: (712) 732-1028
www.meridianmfg.com iowa_warranty@meridianmfg.com

Unit's Model Number _____ Unit's Serial Number _____

- Review safety and operating instructions with owner
- Verify receipt of all options ordered
- Verify that tow vehicle is large enough to safely tow seed tender
- Check engine fuel level. Add as needed
- Check engine oil level. Add as needed
- Start engine and make sure it operates properly
- Check oil level in hydraulic tank. Add as needed
- Check air pressure in tires. Add as needed
- Wheel nuts/bolts are tightened to proper torque on all wheels
- Hitch-to-tongue and hitch-to-frame bolts are tightened to proper torque
- Conveyor tube rotates 180 degrees and locks into towing position
- Weighing system is working properly
- Remote control system is working properly
- All guards/shields are installed correctly
- All safety decals are installed and legible
- Wiring harness plug is in working condition and fit into tow vehicle's receptacle
- Reflectors, plate light, signal lights, and brake lights must be clean and working properly
- Tender's battery is fully charged and in good working order
- Break-away brake system battery is fully charged and in good working order
- Break-away brake cable and pin is supplied with trailer
- Electric brakes are in working condition
- Inspect customer's hitch for 2-5/16" ball or fifth wheel
- Safety chains are properly attached and are in good working condition
- Owner is instructed to check wheel bolt/nut torque at 5, 10, 25, and 50 miles; then check annually

CERTIFICATE OF ORIGIN



MERIDIAN MANUFACTURING INC.
2902 EXPANSION BLVD. STORM LAKE, IA 50588
T: (800) 437-2334 P: (712) 732-1780 F: (712) 732-1028
www.meridianmfg.com iowa_warranty@meridianmfg.com

LICENSING INFORMATION	Delivery Date _____
DEALER _____	SOLD TO _____
Address _____	Address _____
City _____	City _____
State _____	State _____
Zip Code _____	Zip Code _____
Phone Number _____	Phone Number _____
Unit's Model Number _____	Unit's Serial Number _____

This page intentionally left blank

TABLE OF CONTENTS

DESCRIPTION	PAGE
Section 1: INTRODUCTION	1-1
Section 2: SAFETY	2-1
2.1 Safety Orientation	2-2
2.2 General Safety	2-2
2.3 Equipment Safety Guidelines	2-3
2.4 Safety Decals	2-3
2.4.1 Applying Decals	2-3
2.5 Decal Location	2-4
2.6 Work Preparation	2-5
2.7 Placement Safety	2-5
2.8 Lock-Out Tag-Out Safety	2-5
2.9 Maintenance Safety	2-6
2.10 Tire Safety	2-6
2.11 Battery Safety	2-6
2.12 Engine Safety	2-7
2.13 Operating Safety	2-8
2.14 Refuelling Safety	2-8
2.15 Hydraulics Safety	2-8
2.16 Transport Safety	2-9
2.17 Storage Safety	2-9
Section 3: OPERATION	3-1
3.1 Machine Components	3-2
3.2 Components and Controls	3-3
3.3 Control Panel Functions	3-7
3.3.1 Setting Weight to Dispense	3-9
3.3.2 Setting Active Slide Gate	3-9
3.3.3 Auto Reset Function	3-9
3.3.4 Control System Compliance Information	3-9
3.4 Remote Control System	3-10
3.4.1 Functions on the Remote Control Handset	3-10
3.4.2 Handset Display Panel	3-12
3.4.3 Handset Display Messages	3-12
3.5 Machine Break-In	3-14

continue on next page

TABLE OF CONTENTS

DESCRIPTION	PAGE
3.6 Pre-Operation Checklist	3-15
3.7 Attaching To Tow Vehicle	3-16
3.8 Roll Tarp	3-19
3.9 Loading The Tender	3-20
3.10 Delivering Seed To Planter	3-21
3.11 Unplugging	3-23
3.12 Storage	3-24
Section 4: SERVICE AND MAINTENANCE	4-1
4.1 Fluids and Lubricants	4-1
4.2 Servicing Intervals	4-3
4.2.1 Every 10 Hours or Daily	4-3
4.2.2 Every 50 Hours or Weekly	4-3
4.2.3 Every 100 Hours or Monthly	4-4
4.2.4 Every 200 Hours or Annually	4-4
4.3 Maintenance Procedures	4-5
4.3.1 Engine Maintenance	4-5
4.3.2 Hydraulic System	4-6
4.3.3 Conveyor Belt Tension	4-8
4.3.4 Conveyor Belt Tracking Adjustment	4-8
4.3.5 Conveyor Belt Replacement	4-9
4.3.6 Turntable Platform Chain Drive	4-10
4.3.7 Trailer Break-Away System	4-11
4.3.8 Remote Control Handset	4-12
4.3.9 Handset To Receiver Synchronization	4-12
4.3.10 Changing Handset Sleep Time	4-12
4.3.11 Control Panel Error Codes	4-13
4.3.12 Weigh Scale Load Cells	4-14
4.3.13 Axle, Trailer, Frame Bolts	4-15
4.4 Service Record	4-17
4.5 Ordering Parts	4-18
Section 5: TROUBLESHOOTING	5-1
Section 6: REFERENCE	6-1
6.1 Specifications	6-1
6.2 Bolt Torque	6-3
Warranty Statement	

Section 1: INTRODUCTION

Thank you for choosing a Meridian® Bulk Seed Tender®. The equipment we design and manufacture to meet the exacting standards of the agricultural industry.

Keep this manual for future reference. Call your dealer, distributor or Meridian if you need assistance, information, additional/replacement copies or a digital copy of this document.

The information provided herein is of a descriptive nature. Meridian Manufacturing Inc. reserves the right to modify the machinery design and specifications provided herein without and preliminary notice.

Performance quality may depend on the material being handled, weather conditions and other factors.

OPERATOR ORIENTATION

The directions left, right, front, and rear, as mentioned throughout this manual, are as seen from the tow vehicle driver's seat, facing in the direction of travel.

SERIAL NUMBER

Always give your dealer the serial number when ordering parts, requesting service or asking for other information. The tender's serial number is located on the leg beside the conveyor tube.

Use the space provided for easy reference.

Tender Model No: _____

Tender Serial No: _____

Engine Model No: _____

Engine Serial No: _____



Fig 1 - Serial number located on leg



Meridian® continuously enhances its product offering through product improvements and new product innovations. Marketplace feedback, technological innovation, new materials and manufacturing methods, and a philosophy of continuous improvement constantly challenge the company to develop new and better ways of addressing market needs. Meridian® is committed to innovation and reinvestment and as a result, the company maintains a portfolio of patents and intellectual property. For more information on our patents please see our website:

www.meridianmfg.com/patents

Section 2: SAFETY

The Safety Alert Symbol means:

**ATTENTION!
BECOME ALERT!
YOUR SAFETY IS INVOLVED!**

3 Big Reasons why safety is important to you:

- Accidents Disable and Kill
- Accidents Cost
- Accidents Can Be Avoided

The Safety Alert Symbol identifies important safety messages on the seed tender and in this manual.

The following signal words are used in this manual to express the degree of hazard for areas of personal safety.

When you see the symbol and/or the signal words described below, obey the accompanying message to avoid possible injury or death.



Indicates a hazardous situation that, if not avoided, will result in death or serious injury. This signal word is limited to the most extreme situations. Typically for machine components which, for functional purposes, cannot be guarded.



Indicates a hazardous situation, if not avoided, could result in death or serious injury. This word identifies hazards that are exposed when guards are removed. It may be used to alert against unsafe practices.



Indicates a hazardous situation, if not avoided, could result in minor or moderate injury. It may be used to alert against unsafe practices.



Indicates practices or situations which may result in the malfunction of, or damage to equipment.



Safety instructions (or equivalent) signs indicate specific safety-related instructions or procedures.

2.1 SAFETY ORIENTATION

YOU are responsible for the SAFE operation and maintenance of your Meridian® Seed Tender. Be sure that everyone who will operate, maintain or work around it, is familiar with the safety, operating and maintenance procedures.

This manual will take you step-by-step through your working day. It will alert you to all the safe practices that should be adhered to while operating the tender.

Remember, you are the key to safety. Good safety practices not only protect you but also the people around you. Make these practices a regular part of your safety program. Be certain that everyone who will work with this equipment follows these procedures.

Most accidents can be prevented. Do not risk injury or death by ignoring good safety practices.

- Tender owners must give operating instructions to operators or employees before allowing them to operate the machine.
 - Procedures must be reviewed annually thereafter, as per OSHA (Occupational Safety and Health Administration) regulation 1928.57.
 - The operator must be responsible, properly trained and physically able. You should be familiar with farm machinery in general.
- Think SAFETY! Work SAFELY!

2.2 GENERAL SAFETY

- Read and understand the Operator's Manual and all safety decals before operating, maintaining, adjusting or unplugging the auger. 

- Only trained competent persons shall operate the tender. An untrained operator is not qualified to operate the machine.

- Have a first-aid kit available for use should the need arise. 

- Provide a fire extinguisher for use in case of an accident. Store in a highly visible place. 

- Do not allow riders.

- Do not allow children, spectators or bystanders within hazard area around the machine.

- Wear appropriate protective equipment (PPE). This list may include but is not limited to:

- Hard hat
- Protective shoes with slip resistant soles
- Eye protection
- Work gloves
- Hearing protection
- Respirator or filter mask
- Hi-Visibility safety vest



- Never use alcoholic beverages or drugs which can hinder alertness or coordination while operating this equipment.
 - Consult your doctor about operating this machine while taking prescription medications.

- If the elderly are assisting with farm work, their physical limitations need to be recognized and accommodated.

- Review safety related items annually with all personnel who will be operating or maintaining the conveyor.

2.3 EQUIPMENT SAFETY GUIDELINES

Safety of the operator and bystanders is one of the main concerns when designing and developing this tender. However, every year many accidents occur which could have been avoided by a few seconds of thought, and a more careful approach to handling equipment.

- In order to provide a better view, some images in this manual may show an assembly with safety guards removed.
 - Equipment should never be operated in this condition. All guards must be in place. If removal becomes necessary for repairs, replace the guard prior to use.
- This equipment is dangerous to children and persons unfamiliar with its operation.
- Never exceed the limits of a piece of machinery. If its ability to do a job, or to do so safely, is in question - DO NOT TRY IT.
- Do not modify the equipment in any way. Unauthorized modification result in serious injury or death and may impair the function and life of the equipment.
- The design and configuration of this tender includes safety decals and equipment. They need to be clean, readable and in good condition.



2.4 SAFETY DECALS

- Keep safety decals clean and legible at all times.
- Replace safety decals that are missing or have become illegible.
- Replaced parts must display the same decal(s) as the original parts.
- All safety decals have a part number in the lower right hand corner. Use this part number when ordering replacements.
- Safety decals are available from your authorized distributor, dealer's parts department or from Meridian Manufacturing Inc.

2.4.1 Applying Decals:

1. Be sure the application area is clean and dry. Ensure the surrounding temperature is above 50°F (10°C).
 - a. Remove all dirt, grease, wax from surface.
 - b. Clean the area with a non-ammonia based cleaner.
 - c. Wipe the clean surface with isopropyl alcohol on paper towel, and allow to dry.
2. Determine the exact position before you remove the backing paper.
3. Peel a small portion of the split backing paper.
4. Align the decal over the specified area. Use a squeegee to carefully press the small portion, with the exposed adhesive backing, into place.
5. Slowly peel back the remaining paper and carefully smooth the rest of the decal into place.
6. Small air pockets can be pierced with a pin and smoothed out using the squeegee, or a piece of sign backing paper.

2.5 DECAL LOCATION

The following illustrations show the general location of decals on this tender. The position of decals may vary depending on the machine's options. Decals are not shown at actual size.



Fig 2 - Ladder-side of tender



Fig 3 - Other side of tender

2.6 WORK PREPARATION

- Never operate the tender and its engine until you have read this manual, and understand the information.
- Be familiar with the safety messages found on the decals around this unit.

- Personal protective equipment (PPE) include:

- Hard hat
- Eye protection
- Protective shoes
- Work gloves



They are recommended during installation, placement, operation, maintenance and removal of the equipment.

- Do not allow long hair, loose fitting clothing or jewelry to be around equipment.
- **PROLONGED EXPOSURE TO LOUD NOISE MAY CAUSE PERMANENT HEARING LOSS!**

Agricultural equipment can often be noisy enough to cause permanent, partial hearing loss. We recommend that you wear hearing protection on a full-time basis if the noise in the Operator's position exceeds 80 db.



Noise over 85 db on a long-term basis can cause severe hearing loss.

Noise over 90 db adjacent to the operator over a long-term basis may cause permanent, total hearing loss.

Note:

Hearing loss from loud noise (tractors, chain saws, radios, etc.) is cumulative over a lifetime without hope of natural recovery.

- Clear working area of stones, branches or hidden obstacles that might be hooked or snagged, causing injury or damage.
- Operate only in daylight or good artificial light.
- Be sure machine is in a stable position, is adjusted and in good operating condition.
- Ensure that all safety guards and safety decals are properly installed and in good condition.
- Before starting, inspect the unit for any loose bolts, worn parts, cracks, leaks or frayed belts. Make the necessary repairs.
 - Always follow the maintenance instructions.

2.7 PLACEMENT SAFETY

- Stay away from overhead obstructions and power lines. Electrocution can occur without direct contact. 
- Locate the tender providing enough space to load or unload.
- Position tender on level ground, free of debris.

2.8 LOCK-OUT TAG-OUT SAFETY

- Establish a formal Lock-Out Tag-Out program for your operation.
- Train all operators and service personnel before allowing them to work around the area.
- Provide tags on the machine and a sign-up sheet to record tag out details.

2.9 MAINTENANCE SAFETY

- Review Section 4: Service and Maintenance, before maintaining or operating the tender.
- Follow good shop practices:
 - Keep service area clean and dry.
 - Be sure electrical outlets and tools are properly grounded.
 - Use adequate light for the job.
- Place all controls in neutral or off. Stop engine, and remove ignition key. Wait for all moving parts to stop before servicing, adjusting, repairing.
- Keep hands, feet, hair, and clothing away from all moving/rotating parts.
- Replace parts with genuine factory replacements parts to restore your equipment to original specifications.
 - Meridian Manufacturing Inc. will not be responsible for injuries or damages caused by using unapproved parts and/or accessories.
- Make sure there is plenty of ventilation. Never operate the engine in a closed building. The exhaust fumes may cause asphyxiation.
- Clear the area of bystanders, especially children, when carrying out any maintenance and repairs or making any adjustments.
- Place stands or blocks under the frame before working beneath the machine.
- Before resuming work, install and secure all guards when maintenance work is completed.
- Replace damaged or not clearly visible decals.



2.10 TIRE SAFETY

- Failure to follow procedure when mounting a tire on a wheel or rim can produce an explosion and may result in serious injury or death.
- Do not attempt to mount a tire unless you have proper equipment and training to do the job.
- Have a qualified tire dealer or repair service perform required tire maintenance.
- When replacing worn tires, make sure they meet original tire specifications. Never undersize.
- Reference the tire side wall for information on the maximum cold tire pressure (PSI). Keep the tires inflated to this setting.





2.11 BATTERY SAFETY

- Keep all sparks and flames away from battery, as the gas given off by electrolyte is explosive.
- Avoid contact with battery electrolyte. Wash off any spilled electrolyte immediately.
- Wear safety glasses when working near batteries.
- Do not tip batteries more than 45 degrees, to avoid electrolyte loss.
- To avoid injury from spark or short circuit, disconnect battery ground cable before servicing any part of electrical system.
- When storing tender for an extended period:
 - Remove the battery.
 - Be sure it is fully charged.
 - Store it inside.
 - Do not sit battery on a cold, concrete floor.
- Before using battery, after storage, check charge.
- Never attempt to jump start a frozen battery.



2.12 ENGINE SAFETY

- Read and understand the operating manual provided with the engine. 
- Use proper tools to service engine.
- Do not run engine in an enclosed area. Exhaust gases contain carbon monoxide, an odorless and deadly poison.
- Store fuel in approved safety containers.
- Do not store fuel near open flame.
 - Appliances such as a stove, furnace, or water heater use a pilot light which can create a spark.
- No smoking when filling fuel tank. 
- Do not remove fuel cap while engine is running.
- Do not refuel indoors where area is not well ventilated. Outdoor refueling is preferred.
- Do not refuel while engine is running. Allow engine to cool for 5 minutes before proceeding.
- Use fresh fuel. Stale fuel can gum carburetor and cause leakage.
- Check fuel lines and fittings frequently for cracks or leaks. Replace if necessary.
- Do not operate engine if fuel has spilled. Move machine away. Avoid creating any ignition until the fuel has evaporated.
- Do not run engine above rated speeds. This may result in damage and injury.
- Do not tamper with the engine speed selected by the original equipment manufacturer.
- Do not operate engine with grass, leaves, dirt or other combustible materials in muffler area.
- Do not operate engine without muffler.

- Do not tamper with governor springs, governor links or other parts which may increase the governed engine speed.
- Do not strike flywheel with hard object or metal tool. This may cause it to shatter in operation.
- Keep cylinder fins/governor parts free of grass and other debris which can affect engine speed.

WARNING

HOT EQUIPMENT HAZARD

Do not touch muffler, cylinder or fins while engine is running. Contact will cause burns.

- Do not use this engine on any forest covered, brush covered, or grass covered unimproved land, unless a spark arrester is installed on muffler. The arrester must be maintained in effective working order by operator.

In the State of California the above is required by law (Section 4442 of the California Public Resources Code). Other states may have similar laws. Federal laws apply on federal lands.



- Inspect the muffler periodically. Replace it when necessary.
 - If engine is equipped with a muffler deflector, inspect periodically. Replace with correct part.
- Do not check for spark, or crank engine with spark plug or spark plug wire removed.
- Do not run engine with air filter or its cover removed.

NOTICE



POSSIBLE ENGINE DAMAGE

Decelerate engine slowly to stop. Avoid choking the carburetor to stop engine. Choke only for an emergency stop.

2.13 OPERATING SAFETY

- Anyone who will be operating this tender, or working around it, must read this manual. They must know operating, maintenance, safety info. 
 - Review the manual annually.
- Clean or replace all safety decals if they cannot be clearly read and understood.
- Place all controls in neutral, and stop the engine. Remove the ignition key. Wait for all moving parts to stop before adjusting, repairing or unplugging.
- Keep all bystanders, especially children, away from the machine when running.
 - Also, when authorized personnel are carrying out maintenance work.
- Establish a Lock-Out, Tag-Out policy for the work site. Be sure all personnel are trained in and follow all procedures.
 - Lock-Out, Tag Out all power sources before servicing the unit or working around equipment.
- Be familiar with machine hazard area. If anyone enters hazard areas, shut down machine immediately. Clear the area before restarting.
- Keep hands, feet, hair and clothing away from all moving/rotating parts. 
- Do not allow riders on the tender when moving or transporting it.
- Keep working area clean and free of debris to prevent slipping/tripping. 
- Stay away from overhead obstructions and power lines during operation and transporting. Electrocution can occur without direct contact.
- Do not operate the tender when any guards are removed.



2.14 REFUELLING SAFETY

- Handle fuel with care. It is highly flammable.
- Allow engine to cool for five minutes before refuelling. Clean up spilled fuel before restarting engine.
- Do not refuel the machine while smoking or when near open flame or sparks. 
- Fill fuel tank outdoors.
- Prevent fires by keeping machine clean of accumulated trash, straw, grease, and debris. 

2.15 HYDRAULIC SAFETY

- Always place hydraulic controls in neutral. Then relieve pressure in hydraulic system before maintaining or working on machine.
- Be sure that all components in the hydraulic system are kept in good condition and are clean.
- Replace any worn, cut, abraded, flattened or crimped hoses.
- Do not attempt any makeshift repairs to the hydraulic fittings or hoses by using tape, clamps or cements. The hydraulic system operates under extremely high-pressure. Such repairs will fail suddenly and create a hazardous and unsafe condition.
- Wear proper hand and eye protection when searching for a high-pressure hydraulic leak. Use a piece of wood or cardboard as backstop instead of hand to isolate/identify a leak.
- If injured by a concentrated high-pressure stream of hydraulic fluid, seek medical attention immediately. Serious infection or toxic reaction can develop from hydraulic fluid piercing the skin surface.

2.16 TRANSPORT SAFETY

- Lock the conveyor tube in transport position.
- Ensure that the trailer brakes are in good working order. Be familiar with their operation.
- Check that all the lights, reflectors and other lighting requirements are installed and in good working condition. 
- Never allow riders on the tender.
- Be sure the trailer is securely hitched to the towing vehicle and a retainer is used through the hitch jaws. Always attach a safety chain between the hitch and the towing vehicle.
- Stay away from overhead power lines. Electrocutation can occur without direct contact. 
- Comply with all local laws governing safety and transporting of equipment on public roads.
- Do not exceed a safe travel speed. Slow down for rough terrain and when cornering.
- Plan your route to avoid heavy traffic.
- Do not drink and drive.
- Be a safe and courteous driver. Always yield to oncoming traffic in all situations, including narrow bridges, intersections, etc. Watch for traffic when operating near or crossing roadways.

2.17 STORAGE SAFETY

- Store in an area away from human activity.
- If required, make sure the unit is solidly blocked up.
- Remove the battery and store it in a dry location. Do not sit it on a cold concrete floor.
- Make certain all mechanical locks are safely and positively connected before storing.
- Do not permit children to play on or around the stored machine.

This page intentionally left blank

Section 3: OPERATION

WARNING

- Read and understand the Operator's Manual.
- Before servicing, repairing or unplugging; stop engine, remove ignition key and wait for moving parts to stop.
- Clear the area of bystanders, especially children, before starting.
- Do not allow riders on the tender.
- Keep hands, feet, hair and clothing away from all moving and/or rotating parts.
- Be familiar with the hazard area. If anyone unauthorized enters, shut down the machine immediately. Clear area before restarting.
- Do not operate machine with guards removed.
- Keep working area clean and free of debris to prevent slipping or tripping.
- Establish Lock-Out, Tag Out policy for work site. Ensure personnel follow all these procedures. Lock-out tag-out all power sources before servicing or working around equipment.

The Meridian® 240 and 375 RT Seed Express™ Bulk Seed Tenders® have many features incorporated into them as a result of suggestions made by customers like you.

Hazard controls and accident prevention are dependent upon the personnel operating and maintaining it. Their awareness, concern, prudence and proper training are crucial.

It is the responsibility of the owner and operators to read this manual and to train all personnel before they start working with the machine. By following recommended procedure, a safe working environment is provided for the operator, co-workers and bystanders in the area around the work site.

By following the operating instructions, in conjunction with a good maintenance program, your tender will provide many years of trouble free service.

3.1 MACHINE COMPONENTS

A gas engine, mounted on the frame, powers the hydraulic pump. The pump operates the hydraulic motor for the conveyor and the cylinders to raise, lower, and swing the conveyor; as well as open and close the slide gates.

The forward or rear mounted conveyor can swing 180° to transfer seed from the compartments into a planter or drill. Slide gates on the compartments control the flow of seed into the conveyor.

The main components are:

- a. Compartment 1 (Conveyor-end of tender)
- b. Compartment 2 (Tarp Handle-end of tender)
- c. Roll Tarp and Crank Handle
- d. Control Panel
- e. 2 or 3 Axle Trailer (Bumper Hitch or Gooseneck)
- f. Conveyor Tube
- g. Discharge
- h. Gas Engine and Hydraulic Pump
- i. Hydraulic Reservoir
- j. Conveyor Hopper
- k. Transport Lock and Damper Mechanism
- l. Turntable Platform
- m. Compartment Slide Gates
- n. Tool Box
- o. Document Holder (inside frame)

Fig 4 - Tender components



Fig 5 - Tender components

3.2 COMPONENTS AND CONTROLS

Before starting to work, all operators should familiarize themselves with the location and function of the components and controls.

Options and their locations may vary.

Control Panel:

Start the engine, operate the conveyor, open the gates, and work the weigh scale, from the control panel. It is mounted to the side



Fig 7 - Control panel

- a. Electrical System Key Switch:
Turn the key clockwise to turn the electrical system ON. The key must be in the ON position for the engine to start. Turn the key counterclockwise to stop the engine and turn OFF the electrical system.
- b. Engine Start Button (located in Control Box):
Press and hold this button until the engine starts.
 - Set the choke lever on the engine when starting the engine.
 - Turn the key switch counterclockwise to turn OFF the engine.



Fig 6 - Gas engine

Gas Engine:

Read the engine manufacturer's manual for more detailed instructions.

- c. Throttle Lever:
Move the lever laterally to increase or decrease the RPM.
- d. Choke Lever:
Choke the valve for starting when the engine is cold. Open the choke as the engine warms.
- e. Fuel Shut-Off Valve:
Slide the lever toward engine to open.
 - ALWAYS close the valve when not in use or before transporting.
- f. Starting Rope:
Grasp the T-handle firmly and pull the rope sharply to start the engine.
 - The key on master control must be ON to pull-start.

IMPORTANT:

Always run at maximum engine speed.

Battery (12 Volt):

A 12 Volt battery supplies the power to start the engine. When the engine is operating a trickle charge is sent to the battery to keep it fully charged.

Hydraulic Oil Reservoir and Filter:

The oil reservoir and filter are positioned on the side of the hopper.

- Oil Reservoir holds 10 US Gallon (37.8 Liters)

NOTICE

EQUIPMENT DAMAGE HAZARD

- An Anti-Rotation Chain prevents the turntable platform from turning side-to-side when being transported.
 - Unhook the chain before rotating the conveyor to prevent damage.
- Conveyor Turret Wear Pads **MUST** be in contact with the Turret Track **AT ALL TIMES!**

Conveyor Tube Turntable Platform:

The conveyor tube sits on a turntable platform.

- The conveyor tube can be rotated 90 degrees, around to the side.
- The conveyor tube can also be raised or lowered between 14° to 32°.

Transport Lock/Damper Mechanism:

The conveyor tube should be locked when not in use.

- The damper mechanism eases the shocks created by bouncing during road transport.

IMPORTANT:

Always lock the conveyor tube in transport position when not in use.

Compartment Slide Gates:

Hydraulics are used to open and close the compartment gates.



Fig 8 - Engine, hydraulic oil reservoir and filter



Fig 9 - Conveyor tube rotating system



Fig 10 - Conveyor tube damper mechanism and transport lock



Fig 11 - Compartment slide gate cylinders

Conveyor Tube Discharge:

The hydraulic drive for the conveyor belt is located at the discharge.



Fig 12 - Conveyor discharge spout

Roll Tarp:

ALWAYS keep the compartments covered when not being filled. Store the tarp crank handle in the bracket located on the end of the tender.



Fig 13 - Roll tarp and crank handle

Compartment Ladder:

The ladder is located on the side of the tender. Keep the ladder rungs clean to prevent a slipping hazard.

Tool Box:

A tool box is mounted to the corner of the tender. It is a convenient place to keep the remote control, and control box keys.

Tender Trailer:

The tender is available with a bumper hitch or gooseneck hitch trailer. Both trailers are equipped with a jack at the nose. It is important to lower the jack when using the tender to give stability.



Fig 14 - Gooseneck trailer

All trailers are equipped with a Break-Away brake system. It is located near the nose. See page 3-6 for more information.

Weigh Scale System (Optional):

If the tender is equipped with a weigh scale, load cells will be mounted inside the tender frame at each corner.

The display and operation is integrated with the control panel. See Page 3-8



Fig 15 - Tongue on a bumper hitch trailer

Break-Away System:

A Break-Away Switch is installed on all trailers.

The control box contains LEDs to show the condition of enclosed battery. There is a Test button to check the battery level.

IMPORTANT:

Test the Break-Away Switch periodically.
Removing the pin, then pull the trailer to feel if the brakes have engaged.

The cable attached to the Break-Away Switch pin, must go around the ball before coupling the trailer to the tow vehicle.

During transportation, if the trailer should detach from the transport vehicle, the pin will be pulled out engaging the trailer's brakes.

NOTICE

TRANSPORT HAZARD
Always secure the safety chains to the tow vehicle, in addition to the Break-Away Switch.



Fig 16 - Break-Away system control box



Fig 17 - Break-Away cable on hitch tongue

3.3 CONTROL PANEL FUNCTIONS

The MEGA REMOTE system is a state-of-the-art microprocessor based Radio Frequency (RF) control system. It provides the operator the ability to operate the seed tender from the remote control handset or the control panel.

Note:

The controls on this panel are intended to be used only as a backup resource. All of the functions of the seed tender can more easily be controlled using the handset.



Fig 18 - Control panel

- a. LCD Display:
Turning key switch (b) to the ON position will turn the LCD backlight ON. It will stay on until the key is turned to the OFF position.
- b. On/Off Key Switch:
This key switch controls the power to the electrical system. Turn the key clockwise to turn the electrical system ON. The key must be in the ON position for the engine to start or the handset to function. Turn the key counterclockwise to turn OFF the electrical system.
- c. Starting Engine:
Press and hold this button until the engine starts. Also set the choke lever on the engine when starting the engine. Turn the key counterclockwise to turn OFF the engine.
- d. Conveyor Lift and Lower:
This toggle switch raises and lowers the conveyor.
- e. Conveyor Swing (Left/Right):
This toggle switch will swing the conveyor sideways.
- f. Conveyor On and Off:
This switch starts and stops the conveyor belt. Press the switch UP to start the belt and DOWN to stop it.
- g. Slide Gate Switches:
These switches open and close the slide gate at the bottom of each compartment. Press and hold the switch UP to open the slide gate; press and hold the switch DOWN to close the slide gate. The opening can be varied to provide the desired flow rate of seed onto the conveyor belt.

Note:

The following buttons are operable only when the tender is equipped with a weigh scale kit.

h. Decrease:

Decreases the weight when setting the Weight to Dispense function.

From the Main Display screen, to darken the LCD display contrast press the Increase button.

Press and hold both the Increase and Decrease buttons simultaneously for ten seconds to enable or disable the display screen.

i. Increase:

Increases the weight when setting the Weight to Dispense function.

From the Main Display screen, to lighten the LCD display contrast press the Increase button.

Press and hold both the Increase and Decrease buttons simultaneously for ten seconds to enable or disable the display screen.

j. Scroll:

Press the scroll button to scroll between the various display pages.

- Main Display screen (shows weight)
- Weight To Dispense screen (shows amount of seed that will be delivered to planter)
- Active Slide Gate screen
- Auto Reset screen

k. Tare:

To "Tare" or zero the scale when the control panel receiver display is on the main display page showing the weight, press and hold the Tare push button on either the handset or the control panel for three seconds. The display will then show the weight as zero.

ENABLE/DISABLE DISPLAY:

Hold both INCREASE and DECREASE push buttons on the control box simultaneously for 10 seconds to enable or disable the display.

BAR PAGE:

On the BAR PAGE where all weights are shown separately, holding down the TARE button on the control box for 10 seconds will zero the reading for all the bars.

3.3.1 Setting Weight to Dispense:

1. Select the Weight To Dispense screen using the Scroll button (j).
2. Press and hold the Tare button (k) for five seconds.
3. The first character of the weight will start blinking.
4. Use the Increase (i) or Decrease (h) buttons to select the appropriate number.
5. Use the Scroll button to move to the next digit. Use the Increase (i) or Decrease (h) buttons to select the appropriate number. Repeat this until the desired weight has been entered.
6. Finally, holding the Tare button (j) for another five seconds to save the new weight.

Note:

The weight of the seed is calculated when it is inside the compartments and as it flows through the slide gates. Any seed in the seed pan or the conveyor has already been weighed and does not affect the total weight.

3.3.2 Setting Active Slide Gate:

1. Select the Active Slide Gate screen using scroll button (j).
2. Use the Increase/Decrease buttons to set the slide gate to either #1 or #2.
3. When the Auto Reset button is pressed on the handset, the slide gate selected will open automatically.

3.3.3 Auto Reset Function:

1. Using the Weight To Dispense screen, select the desired weight of seed to be delivered to the planter.
2. Using the Active Slide Gate screen, select either compartment 1 (Slide Gate 1) or compartment 2 (Slide Gate 2).
3. Press the Auto Reset button on the handset. The unit monitors the weight of seed being dispensed. As the weight approaches the desired Weight To Dispense, the slide gate will begin to close. If the weight stops changing too soon, the unit will open the slide gate slowly in order to get the desired amount.

3.3.4 Control System Compliance Information:

This equipment has been tested and found to comply with the limits for a Class B digital device, pursuant to part 15 of the FCC Rules. These limits are designed to provide reasonable protection against harmful interference. This equipment generates radio frequency energy and if not installed and used in accordance with the instructions, may cause harmful interference to radio communications. However, there is no guarantee that interference will not occur in a particular installation. If this equipment does cause harmful interference to the reception of other electronics, which can be determined by turning the equipment off and on, DO NOT operate this equipment around those devices.

This equipment has been certified to comply with the limits for a Class B computing device, pursuant to FCC Rules. In order to maintain compliance with FCC regulations, shielded cables must be used with this equipment. Operation with non-approved equipment or unshielded cables is likely to result in interference to electronic device reception. The user is cautioned that changes and modifications made to the equipment without the approval of the manufacturer could void.

3.4 REMOTE CONTROL SYSTEM

Each radio remote control handset transmitter is designed to operate with a unique radio ID code and RF channel sequence. Each control panel receiver is programmed to respond only to the handset transmitter with the correct ID code/RF channel sequence for which it is set. This feature allows multiple systems to work in close proximity to one another without interference.

If the handset goes out of range for more than two seconds, all outputs except CONVEYOR will turn off as a safety feature.

In the event that the handset becomes damaged and a new one is needed, the control panel receiver can be reprogrammed to respond to the new control. Refer to Section 4.3.9 (Page 4-12)

All of the normal functions of the seed tender can be controlled by the remote control handset.

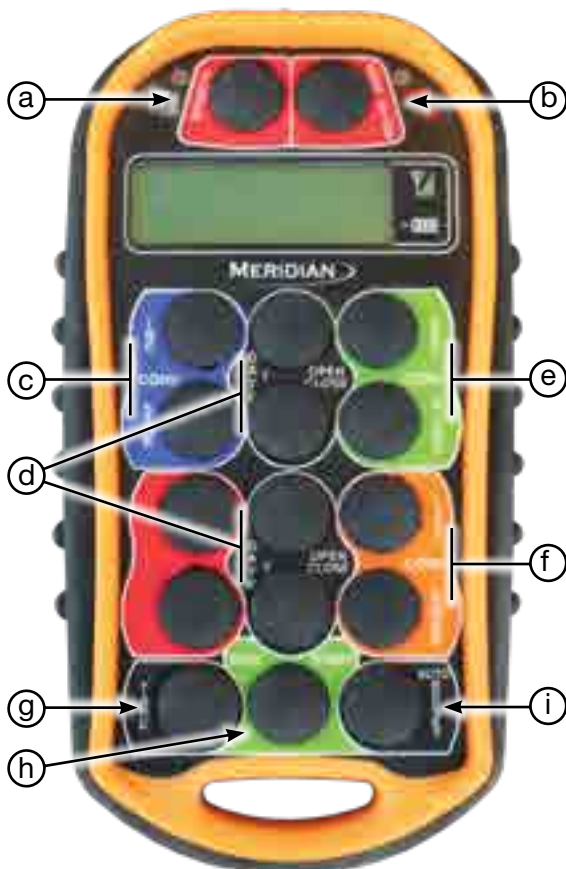

Fig 19 - Remote control handset transmitter

3.4.1 Functions of Handset Buttons:

Use the buttons on the control to operate the functions of the seed tender.

- a. **POWER:**
Press Power button (a) to turn ON the handset. Press and hold the button to turn it OFF.

To save battery life, the handset will automatically turn off when it is idle (no functions are used) for a period greater than the sleep time (default is 15 minutes). Refer to Section 4.3.10 (Page 4-12) to change the sleep time.

Note:

The remote control handset will NOT automatically shut off as long as the control panel receiver has power applied to it.

- b. **ENG STOP:**
Stop the engine with this button.
- c. **CONV - INC/STOP:**
These Conveyor buttons start and stop the conveyor belt.

The conveyor has 3 speeds. Press the INC button once to start the conveyor at low speed. Press the button again for medium speed, and a third time for high speed. The fourth time will return to low speed.

Note: The conveyor will start at the last speed used once stopped, always return conveyor belt speed to low before stopping.

d. SLIDE GATES:

The Slide Gate buttons open and close the slide gates at the bottom of compartment 1 and 2. Hold either button to fully open or fully close. Release to leave the gate partially open, when the desired amount of product flow is achieved.

e. CONV - LEFT/RIGHT:

These Conveyor buttons swings the conveyor tube sideways.

f. CONV - LIFT/LOWER:

These Conveyor buttons raise and lower the conveyor tube.

g. TARE:

The Tare button will reset the scale to zero in order to measure only the content being added to one compartment without measuring the weight of the seed tender itself. This allows an exact measurement of the seed to be placed in the compartment.

h. ENG START:

Start the engine with this button.

Note: If starting a cold engine, close the engine choke.

i. AUTO RESET:

Pressing the AUTO RESET button on the handset will dispense the Weight To Dispense out the selected gate. The gate that was selected in the Active Gate screen will open in #s. The unit will monitor the weight being dispensed. As the weight approaches the desired Weight To Dispense, the gate will begin to close. If the weight stops changing too soon, the unit will open the gate slowly in order to get the desired amount.

- The auto reset mode does not turn the conveyor ON. The desired speed for the conveyor should be set manually.

- If the remote control is in the middle of auto dispense mode and the handset goes out of range, the unit will close all open gates regardless the status of dispensing.

- If the remote goes into the sleep mode during the auto dispense mode, the unit will abort the auto dispense mode and close the active gate.

- Pressing any of the gate function buttons on the handset will close the active gate and stop the auto dispense mode.

- If, during the auto dispense mode, the POWER button is pressed, the active gate will close.

3.4.2 Handset Display Panel:

- (1) Weight Displayed in Pounds.
- (2) Signal Strength.
- (3) Percentage of Battery Life.



Fig 20 - Remote control handset display

3.4.3 Handset Display Messages:

Pressing the POWER button turns the remote control handset transmitter ON and displays the message "Meridian Mega Remote".



Fig 21 - Handset messages

If the "NO LINK" message appears, the remote control handset is not communicating with the control panel on the seed tender. Make sure the ON/OFF key switch is in the ON position.



Fig 22 - No Link message

The handset will display the WEIGHT of the seed in the seed compartments in pounds. It also displays the battery life of the two AA batteries in a percentage of remaining life.



Fig 23 - Handset displays weight

When the POWER button is pressed and held, the message "Transmitter is turning OFF" will be displayed.



Fig 24 - Turn off handset

3.5 MACHINE BREAK-IN

A special break-in procedure has been developed to ensure the integrity of the seed tender when first put into service. Follow the Before Starting instructions and then follow the Inspections for 1/2, 5, and 10 hour instructions at the appropriate interval.

After completing these instructions, follow the normal service schedule in the Maintenance and Service sections and the engine manual.

Before Starting Work:

1. Read and follow the instructions in this manual, and the engine manual.
 - Read the Pre-Operation Checklist.
2. Check wheel bolt torque and then again at 10, 25, and 50 miles.
 - Refer to Section 6.2 Bolt Torque.
3. If needed, adjust the height of the gooseneck hitch assembly. Refer to Section 3.7.2
4. Start the engine and check the controls. Be sure that they function properly.

After Operating for 1/2, 5, and 10 Hours:

5. Check the machine fluid levels.
 - Refill as necessary.
6. Check the tension and alignment of the conveyor belt.
7. Check hardware and fasteners; frame to trailer tie-downs, all fasteners, and wheel bolts. Tighten to their specified torque.
8. At 10 hours, change the engine oil.
 - Check engine manual for the specified oil.

3.6 PRE-OPERATION CHECKLIST

Efficient and safe operation of this Meridian® Bulk Seed Tender® requires that each operator reads and follows the operating instructions and all related safety precautions identified in this manual.

This pre-operational checklist is provided for both personal safety and to maintain the efficient operation of the tender. Check the following areas, each time, before you operate this tender:

1. Lubricate the machine.
 - Refer to Service and Maintenance section.
2. Check the engine oil and fuel levels.
 - Add, if required.
3. Check hardware and fasteners; seed tender frame to trailer tie-downs, hitch bolts, trailer hitch to trailer bolts, and all other fasteners. Tighten to their specified torque.
4. Make sure the wheel bolt lug nuts are tight.
5. Check the tires to be sure that they are inflated to their specified pressure.
6. Remove all entangled material.
7. Visually inspect the conveyor tube, conveyor belt, and delivery spout for damage.

IMPORTANT:

The engine warranty is void if the engine is run without oil.

8. Test the Break-Away brake unit and the trailer brakes.
 - a. Make sure the trailer brakes are operating properly.
 - b. Be sure the trip wire to the break-away switch is connected to the tow vehicle.
 - c. Make sure the pin is correctly installed in the break-away switch.
 - d. Press the Test button to see if the indicator illuminates green.
 - If the red light illuminates, the battery charge is low.
 - Recharge the battery.
9. Check the fluid level in the hydraulic reservoir.
 - Add fluid as needed.
10. Check the tension of the conveyor belt.
 - Follow the instructions in the manual to adjust the tension.
11. When the conveyor belt is rotating, check its alignment.
 - Adjust as necessary.

NOTICE

EQUIPMENT DAMAGE HAZARD

- An Anti-Rotation Chain prevents the turntable platform from turning side-to-side when being transported.
 - Unhook the chain before rotating the conveyor to prevent damage.
- Conveyor Turret Wear Pads **MUST** be in contact with the Turret Track **AT ALL TIMES!**

3.7 ATTACHING TO TOW VEHICLE

⚠ WARNING

UPENDING HAZARD

Do not stand over hitch when unhooking the trailer from the tow vehicle.

- Load the compartment closest to hitch first.
- Unload compartment farthest from hitch first. Always keep a positive tongue weight.

⚠ WARNING

CRUSHING HAZARD

Ensure that all bystanders, especially small children, are clear of work area.

Ensure there is enough room and clearance to safely back up to the machine.

IMPORTANT:

Conveyor tube must be locked in transport position at all times while towing.

1. Complete the Pre-Operation Checklist.

3.7.1 Bumper Hitch Trailer:

2. Use the trailer jack to lift the hitch above the height of the receiver on the tow vehicle.
3. Slowly back the tow vehicle until the hitch and ball are aligned.
4. Lower the hitch onto the ball.
5. Release the latch to lock the hitch around the ball
 - Insert a retainer clip, or pad lock to ensure the handle stays in the locked position.
6. Raise the jack and place it in its stowed position.

Compartment 1
(Conveyor-end)

Compartment 2
(Tarp Handle-end)



Fig 25 - Compartment position identification



Fig 26 - Conveyor tube transport lock w/ damper mechanism



Fig 27 - Trailer hitch with safety chains

7. Attach the safety chain securely to the tow vehicle to prevent unexpected separation.
 - Cross the chains when attaching.
8. Connect the wiring harness for the lights and brakes.
9. Connect the break-away system cable to the tow vehicle.
 - Plug the key on the end of the cable into the receiving unit.
10. Route all the cables in a manner that will prevent snagging.
 - Be sure to provide slack for turning.

3.7.2 Gooseneck Hitch Trailer:

WARNING

CRUSHING HAZARD

The adjustable height tube in Figure 32 is very heavy and can cause severe injury if it falls free. Once the lock bolt is loosened and the hitch pin is removed, the tube is free to fall to the ground if not properly supported.

1. Adjust the trailer jack to set the trailer in a level position.
2. Loosen lock bolt (a) on the adjustable height tube. Remove the keeper pin (b) and remove the tube lock pin (c). See Figure 31
3. Adjust the tube height for the tow vehicle which would keep the trailer in a level position.
4. Reinstall the pin and keeper.
 - Tighten the tube lock bolt.



Fig 28 - Break-Away cable



Fig 29 - Gooseneck hitch



Fig 30 - Gooseneck trailer jack



Fig 31 - Gooseneck hitch components

5. Raise the gooseneck ball hitch to go over the lowered tailgate of the tow vehicle and to clear the height of the gooseneck ball.
6. Open the clamp latch on the gooseneck coupler.
7. Position the trailer's coupler directly over the ball in the bed of the tow vehicle.
8. Lower the gooseneck trailer into position and latch the clamp.
9. Attach the safety chains.
10. Connect the trailer light wiring to your vehicle's connector and check all of your lights, including your brake lights.
11. Completely raise the trailer jack to the storage/transport position.



Fig 32 - Gooseneck trailer coupler

3.8 ROLL TARP

NOTICE

COATING DAMAGE POSSIBLE
Always cover the tender with roll tarp when not in use to prevent compartment coating damage.

1. Using both hands, carefully unclip the holder and remove the crank handle.
2. Extend the crank rod to a comfortable operating position.
3. Roll the tarp to the fully opened position.
4. Return the crank handle back into the holder and close to secure.

IMPORTANT:

Always keep the compartments covered when not being filled.

Note:

To provide proper tarp tension, ratchet straps are provide. There is a cable at both ends of the tarp. Insert these cables, into the straps and tighten.



Fig 33 - Remove tarp crank handle



Fig 34 - Open tarp



Fig 35 - Store tarp crank handle



Fig 36 - Tarp tension ratchet straps

3.9 LOADING THE TENDER

NOTICE

UPENDING HAZARD

Tender must be connected to tow vehicle at all times during operation to avoid tipping backwards.

WARNING

UPENDING HAZARD

Always keep a positive tongue weight.

- Load the compartment closest to hitch first.
- Unload compartment farthest from hitch first.

1. Connect the seed tender to a tow vehicle of sufficient size to safely transport it.
2. Before loading the seed tender:
 - Make sure the two slide gates are fully closed.
 - Be sure the sample slide gate are closed.
3. Open the roll tarp.
4. **IMPORTANT:** Fill the compartment closest to the hitch first to maintain a positive tongue weight.
5. Fill the second compartment after the one above the hitch is full.
6. Close the roll-up tarp and store the crank handle in the holder.

Note:

There are sample slide gates, in each compartment, to retrieve samples.



Fig 37 - Compartment slide gates



Fig 38 - Use remote control handset



Fig 39 - Sample slide gates



Fig 40 - Close tarp, store handle

3.10 DELIVERING SEED TO PLANTER

⚠ DANGER

ELECTROCUTION HAZARD

Keep away from power lines.

- Be aware of your surroundings when raising or lowering the conveyor tube.
- Maintain at least 20 feet between the equipment and any electrical hazard.
- Contact with electricity can result in serious personal injury or death.

⚠ WARNING

UPENDING HAZARD

Always unload compartment farthest from hitch first to maintain positive tongue weight.

Negative tongue weight may cause the trailer to upend causing personal injury.

1. Before unloading, shut off engine on the tow vehicle, set the parking brake, and remove the ignition key.

NOTICE

EQUIPMENT DAMAGE HAZARD

An anti-rotation chain prevents the turntable platform from turning side-to-side when being transported.

Unhook the chain before rotating the conveyor to prevent damage.

2. Disconnect the anti-rotation chain from the conveyor's turntable platform.
3. Remove the locking pin from the damper mechanism to release the conveyor tube.
 - The conveyor may need to be lowered slightly to remove tension from locking pin.
 - Store the pin in a safe location.
4. Turn the control panel key switch to ON.



Fig 41 - Conveyor hopper on turntable platform



Fig 42 - Turntable platform anti-rotation chain



Fig 43 - Conveyor tube transport lock and damper mechanism



Fig 44 - Control panel

5. Start the engine:
 - a. Open the Fuel Shut-Off valve.
 - b. To start a cold engine, CLOSE the choke.
 - c. Press the Engine Start button on the control panel, or the remote control.
6. Allow the engine to warm up for two to three minutes.
 - Gradually open the choke as engine warms.
7. Move the Throttle lever to run the engine at full speed.

NOTICE

EQUIPMENT DAMAGE HAZARD
Conveyor Turret Wear Pads
MUST be in contact with the Turret Track
AT ALL TIMES!

8. Rotate and raise/lower the conveyor tube to the desired position.
9. Position the discharge spout over the planter's seed box.
10. Turn on the conveyor belt.
11. The Auto Reset feature may be used to automatically dispense a preselected amount of seed.
 - Refer to Section 3.3.3 Auto Reset Function.
12. Open the slide gate on either compartment.
 - **Note:** The button or switch is only activated while pressed and held. The flow of seed can be controlled by the amount the slide gate is opened.
13. **IMPORTANT:** Close the slide gate, before the planter box is full, to prevent spillage.
14. Run the belt to empty it, and to finish filling the seed box.
 - Turn off the conveyor belt before it overfills.



Fig 45 - Open/close gates



Fig 46 - Fill Seeder



Fig 47 - Secure conveyor tube for transport

15. Turn OFF the engine.
 - Close the Fuel Shut-Off valve.
16. Return the conveyor tube to the transport position and lock securely.
 - Attach the anti-rotation chain.
 - Lock the damper mechanism to the conveyor tube.

3.11 UNPLUGGING

WARNING

ENTANGLEMENT HAZARD

- Do not operate with access door open.
- Do not place hands or fingers near rotating or moving parts.
- Do not operate without guard.
- Stop engine and remove key, before working on the machine.

NOTICE

Do not operate the conveyor when:

- It is plugged with excess seed
 - Hindered from moving by a foreign object.
- Continued operation can cause damage to conveyor or result in a broken conveyor belt.

If the conveyor tube becomes plugged:

1. Position the conveyor for easy access to both ends.
2. Stop the engine and remove the ignition key.
3. Lock-Out, Tag-Out the tender control panel inside the box.
4. Open the lower access door at the base of the conveyor.
5. Remove the spout to gain access if needed.
6. Clean out seed and remove any obstruction.
7. Close and secure the access door.
 - Reattach the spout.

Note:

In some extreme case it may be necessary to remove the galvanized belt guards and/or the belt itself.



Fig 48 - Conveyor tube access door

3.12 STORAGE

SAFETY INSTRUCTIONS

PERSONAL INJURY HAZARD

- Store the tender in an area away from human activity.
- Do not permit children to play on or around the stored machine.
- Store the unit in a dry, level area. Support the frame with planks, if required.

After the season's use or when it will not be used for an extended period of time, the tender should be inspected and prepared for storage.

Repair or replace any worn or damaged components to prevent unnecessary downtime at the beginning of the next season.

1. Remove all product from the compartments and inside the conveyor tube.
2. Inspect all moving or rotating parts and remove any entangled material.
3. Check the condition of the conveyor belt.
4. Check hyd pump, engine shaft and spider.
5. Inspect and clean chain and sprockets on the turntable platform.
6. Close the engine Fuel Shut-Off valve.
7. Remove the ignition key and store securely.
8. Remove the battery.
 - Be sure it is fully charge, check monthly.
 - Store it inside.
 - Do not sit battery on a cold, concrete floor.
9. Thoroughly wash the tender to remove all dirt, mud, debris and residue.
 - Wash around the tender and inside the compartments.
 - Clean inside the conveyor tube, and belt.

10. Lubricate chains, sprockets, grease fittings and conveyor belt roller bearings.

Make sure that all grease cavities have been filled with grease to remove any water residue from the washing. This also protects the bearing seals.

11. Touch up paint nicks and scratches to prevent rusting.
12. Close the roll tarp to protect the compartments.
13. Store the tender inside if possible.
 - If it must be outside, cover with a waterproof tarp and tie down securely.
14. If the tender is not attached to a trailer, support the frame with planks to raise the unit off the ground.

Removing From Storage:

When removing the tender from storage, in preparation for work:

15. Remove the tarp, if covered.
16. Install and connect the battery.
17. Review and follow the Pre-Operation Checklist.
18. Review and follow the Service Intervals in the Maintenance section.

IMPORTANT:

If the machine has been stored for more than twelve months, warm the engine by running it for two to three minutes. Then drain the oil.

Change the oil while the oil is warm to remove any condensation.

Section 4: SERVICE AND MAINTENANCE

WARNING

- Review the Operator's Manual and all safety items before maintaining the tender.
- Follow good shop practices:
 - Keep service area clean and dry.
 - Be sure electrical outlets and tools are properly grounded.
 - Use adequate light for the job at hand.
- Lock-Out, Tag-Out tender operation.
- Clear the area of bystanders, especially children, before repairing or adjusting.
- Keep hands, feet, hair and clothing away from all moving and/or rotating parts.
- Before servicing, repairing or unplugging; stop engine, remove ignition key and wait for moving parts to stop.
- Ensure there is plenty of ventilation. Never operate the engine in a closed building. The exhaust fumes may cause asphyxiation.
- Place stands or blocks under frame before working beneath the unit.
- When maintenance is complete, before resuming work, install and secure all guards.
- Keep safety decals clean. Replace any decal that is damaged or not readable.

By following the operating instructions, in conjunction with a good maintenance program, your tender will provide many years of trouble free service.

Original Equipment Manufacturer (OEM) literature, for components of this tender, are stored in the document holder, attached to the tender frame. For more specific information contact the manufacturer directly.

4.1 FLUIDS AND LUBRICANTS

Fuel and Engine Oil:

Refer to the engine manual for specific information:

- Fuel tank capacity: 6.4 US quarts (6.1 liters)
- Crankcase: 1.16 US quarts (1.1 liters)

Grease:

Use an SAE multipurpose high temperature grease with extreme pressure (EP) performance. Also acceptable, SAE multipurpose lithium based grease.

Hydraulic Oil:

Use ISO grade 32 fluid (AW HVI or comparable).

- Oil Reservoir holds 10 US Gallon (37.8 Liters)

Storing Lubricants:

Your machine can operate at top efficiency only if clean lubricants are used. Use clean containers to handle all lubricants.

Store them in an area protected from dust, moisture and other contaminants.

4.1.1 Greasing:

NOTICE

GREASING HAZARD

Too much grease causes excessive overheating.
Under-greasing accelerates equipment wear.

No grease should be seen around bearings.
If there is, too much grease was applied
and the seal has ruptured!

IMPORTANT:

- Grease bearings only one pump per month under normal usage conditions.
 - Bearing greasing frequency should be determined by usage and conditions.
1. Use a hand-held grease gun for all greasing.
 2. Wipe grease fitting with a clean cloth before greasing, to avoid injecting dirt and grit.
 3. All bearings are greasable, but require only minimal grease.
 - Recommended greasing is one small stroke every month. Be careful not to over-grease as this may push the seal out.
 4. Replace and repair broken fittings immediately.
 5. If fittings will not take grease, remove and clean thoroughly. Also clean lubricant passageway. Replace fitting if necessary.

4.2 SERVICING INTERVALS

The following recommended periods are based on normal operating conditions. Severe or unusual conditions may require more frequent lubrication and oil changes.

Schedules may vary depending on options and engine model contained in your equipment.

WARNING

FIRE HAZARD

Gasoline is a highly combustible fuel. Improper use, handling, or storage of gasoline can be dangerous. Never touch or fill a hot engine.

- DO NOT fill fuel tank near an open flame, while smoking or while engine is running.
- DO NOT fill tank in an enclosed area with poor ventilation.
- Wipe up spills immediately.

IMPORTANT:

Refer to the engine manual for complete servicing and maintenance details.

The axle is built by Dexter Axle Company. Refer to their online maintenance information.



Fig 49 - Engine air filter

4.2.1 Every 10 Hours or Daily:

1. Check engine oil level.
 - Fill as needed.
2. Check engine fuel level.
 - Add as needed.
3. Check hydraulic oil level and filter.
 - Add as needed.
4. Test trailer break-away system.
5. Inspect tires.
6. Check wheel bolt torque at 10, 25, and 50 miles.
7. Check conveyor belt tension and alignment.
8. Inspect all conveyor belt rollers and bearings for play and wear.
9. Check remote control handset battery life.

4.2.2 Every 50 Hours or Weekly:

10. Clean or replace the engine air filter element.
 - Clean or replace the foam filter.
 - Replace the paper air filter, as required.
11. Inspect the hydraulic pump-to-engine shaft coupling and spider.
12. Clean handset with a damp cloth and mild detergent.
13. Check the tire pressure. Inflate tires to the recommended pressure stated on the tire.

4.2.3 Every 100 Hours or Monthly:

14. Grease conveyor belt roller bearings.
15. Grease the hydraulic cylinders.
16. Check the turntable platform chain drive.
 - Inspect the chain, and sprocket teeth.
17. Check wheel nuts.
 - Torque to 90-120 ft-lb
18. Adjust the trailer brakes.
19. Inspect tires for wear.
20. Grease the axles.
21. Inspect brake magnets for wear.
22. Inspect suspension parts for wear.
23. Check battery electrolyte levels, and clean terminals to remove dirt and corrosion.

4.2.4 Every 200 Hours or Annually:

24. Change the engine oil.
25. Check hydraulic oil for contaminants.
26. Check hydraulic hoses and fittings for wear.
27. Check nylon slide blocks on the turntable.
28. Tighten the rubber stop bumpers, which are beside the chain drive.
29. Check that battery retains maximum charge.
30. Inspect brake lining wear:
 - Check brake cylinder for leaks.
 - Inspect brake wiring for damage.
31. Repack the wheel bearings:
 - Check for excessive play in the bearings.
 - Grease the wheel bearings.

32. Check the wheel hub for wear.
33. Inspect axle grease seal for leakage.
34. Inspect springs for any wear or loss of arch.
35. Inspect all electrical wiring connections for looseness or corrosion.
 - Tighten and/or seal, as necessary.
36. Check trailer axle, frame, hitch and tender hold-down bolts.
 - Refer to Section 6.2 Bolt Torque.
37. Thoroughly clean the tender.
 - Wash to remove all dirt, mud, debris and residue.
 - Wash around and inside the intake hopper and chutes.
 - Clean inside the conveyor tube, and belt.



Fig 50 - Trailer wheels



Fig 51 - Discharge roller bearing

4.3 MAINTENANCE PROCEDURES

4.3.1 Engine Maintenance:

Refer to the engine manual for complete details.

SAFETY INSTRUCTIONS

REFUELLING HAZARD

- Handle fuel with care. It is highly flammable.
- Allow engine to cool for five minutes before refuelling. Clean up spilled fuel before restarting engine.
- Do not refuel the machine while smoking or when near open flame or sparks.
- Fill fuel tank outdoors.
- Prevent fires by keeping machine clean of accumulated trash, straw, grease, and debris.

Approved Fuel:

Use unleaded automotive gasoline for all operating conditions. The fuel tank capacity is 6.4 US quarts (6.1 liters).

Engine Oil:

Use a typical SAE 10W-30 or 10W-40 multiviscosity motor oil for normal operating conditions. Consult your engine manual for the recommended oil in cold temperatures. The crankcase capacity is 1.16 US quarts (1.1 liters).

Engine Circuit Protection (if equipped):

The circuit protector protects the battery charging circuit. A short circuit, or a battery connected with reverse polarity, will trip the circuit breaker.

The green indicator inside the circuit protector will pop out to show that the circuit protector has switched off. If this occurs, determine the cause of the problem, and correct it before resetting the circuit protector.

Push the circuit protector button to reset.

Change Engine Oil:

⚠ CAUTION

BURN HAZARD

Hot engine oil can burn skin.

1. Review the engine manual.
2. Allow the engine to cool before changing oil. Draining works best when the oil is warm.
3. Be sure the engine key switch is in the OFF position and the fuel valve is turned OFF.
4. Place a pan under the drain plug. Remove the drain plug and allow the oil to drain for ten minutes.
5. Reinstall the drain plug and tighten.
6. Dispose of the oil in an approved container.
 - Follow industrial disposal regulations.
7. Fill the engine with SAE 10W-30 oil for general usage. If the engine is operated in more extreme conditions, refer to the engine manual for oil recommendations.
8. Run the engine for one minute and recheck the oil level. Add oil, as needed.

Air Cleaner and Filter:

Check and remove any debris from the foam cover of the air cleaner daily before each use. Thoroughly wash or replace the foam cover every three months or 50 hours of operation (clean it more frequently when used in dusty conditions).

4.3.2 Hydraulic System:

Hydraulic oil and filter change is recommended annually or every 400 hours of operation using an AW HVI Hydraulic ISO 32 oil.

IMPORTANT:

Never run the hydraulic pump unless the hydraulic oil reservoir is full.

1. Place a large waste oil container under the hydraulic reservoir drain port.
2. Remove the drain plug from the reservoir.
 - Allow to drain completely.
3. Remove and replace the oil filter.
 - Apply a thin coat of oil to the rubber seal of the new oil filter. Hand-tighten only.
4. Re-install the drain plug.
5. Fill the tank to the fill line at the top of the gauge with AW HVI Hydraulic ISO 32 oil.
6. Replace the cap.
7. Start the engine and cycle all the cylinders several times.
8. Recheck the oil level in the reservoir and add as needed.



Fig 52 - Hydraulic oil reservoir and filter



Fig 53 - Hydraulic valve manifold

Hydraulic Valve Manifold:

IMPORTANT:

The valve manifold contains pressure relief valves and solenoids which have been factory installed and set up for the most efficient operation. **DO NOT** adjust relief valves or replace solenoids. If the unit is not operating properly, refer to the Troubleshooting section, call an authorized dealer, or call the factory.

Hydraulic Pump Coupling:

Changing the pump coupling does not require the hydraulic tank to be drained. If the pump must be disconnected, be prepared to catch any oil that remains in the two hydraulic hoses.

1. Remove the orange protective cover from the pump assembly.
2. Remove the two pump mounting bolts.
3. Pull the pump away from the adapter to separate the coupling halves.
4. Loosen the setscrews in each coupling half and remove the old couplings.
5. Install new couplings on the engine shaft and the pump shaft. When completely assembled, the shaft length in each coupling half should be the same. Tighten the pump end setscrews to 78 to 87 lb-in. Do not tighten the engine shaft coupling at this time.
6. Place the urethane spider in the pump coupling. Align and install the pump and pump coupling.
7. Tighten the pump bolts to a “Grade 5” bolt torque for that size of bolt. Refer to Section 6.2 Bolt Torque.
8. Slide the engine coupling against the other coupling half and tighten the setscrew.
9. Replace the orange protective cover.

Note:

If the adapter plate was removed, tighten the four retaining bolts to “Grade 5” bolt torque for that size bolt.



Fig 54 - Engine and hydraulic pump



Fig 55 - Hydraulic coupler

4.3.3 Conveyor Belt Tension:

1. Loosen the locknut on each side of the hopper roller tension bolt.
2. Tighten the two tension bolts equally.
 - While holding the tension bolt in place, retighten both locking nuts.
3. Start the conveyor and make sure the belt is tracking in the center of the roller.
 - If the belt is not tracking properly, use the Belt Tracking Adjustment procedure to correct the problem.



Fig 56 - Hopper roller tension bolt

4.3.4 Conveyor Belt Adjustment:

IMPORTANT:

The hopper roller at the bottom of the conveyor must be square (roller shaft must be equal distance from end of unit) for the belt to track properly.

Note:

If belt is not tracking correctly, it will move to the loose side. Tighten loose side or loosen tight side.

1. Adjust one side at a time.
 - Loosen the locking nuts on the adjusting bolt.
2. Tighten or loosen the bolt on one side, to correct the tracking.
3. Using a wrench, hold the adjusting bolt in place while tightening the locking nut against the housing.
4. Slowly, test run the conveyor belt.
 - Check if the belt is tracking centered.
 - Re-adjust, if needed.



Fig 57 - Discharge adjustment bolt

4.3.5 Conveyor Belt Replacement:

1. Position tube for easy access to both ends.
2. Open the access door.
3. Loosen the lower drive drum adjusting bolts.
4. If the old belt can be used to thread the new belt, continue with this step; if not, continue to Step 5.
 - a. Remove belt guard to access belt lacing.
 - b. Disconnect the lacing.
 - c. Attach the replacement belt to the end of the old conveyor belt.
 - d. Slowly pull the old belt out of the spout, threading the new one into position.
 - e. Disconnect the old belt and connect the lacing of the new belt together.
5. If the old belt cannot be used:
 - a. Remove the discharge spout.
 - b. Remove the galvanized belt guards.
 - c. Thread the new belt through the tube.
 - d. Connect the two ends of the belt lacing.
6. Push the lacing cable through the lacing.
 - a. Cut off excess cable.
 - b. Crimp the lacing at one end to lock cable in place.
 - c. Cut and taper the corners, of the trailing end of the belt, so they don't catch.
7. Tighten the two drive drum tension bolts.
 - Refer to Section 4.3.3
8. Start the engine. slowly run the conveyor to make sure the belt tracks properly.
 - If the belt does not track properly, refer to Section 4.3.4.
9. Recheck the tension and alignment of the belt frequently during the first ten hours of operation and adjust, as needed.

Note:

The belt normally seats itself during the first 10 hours of operation and can be checked weekly



Fig 61 - Access door



Fig 58 - Thread lacing cable



Fig 60 - Crimp lacing and taper belt corner



Fig 59 - Conveyor belt lacing

4.3.6 Turntable Platform Chain Drive:

The chain, rotating the turntable, should be periodically maintained to ensure a long service life. Regularly inspect the chain for potential problems and to avoid premature failure. Early identification of a problem is crucial to prevent costly downtimes.

- The chain drive will operate successfully with little or no lubrication beyond the initial factory lubrication. However, periodic lubrication will greatly extend the functional life of the chain drive. The chain drive requires lubrication for four purposes:
 - a. Resist wear of the pin-bushing joint.
 - b. Cushion impact loads.
 - c. Lubricate chain/sprocket contact surfaces.
 - d. Retard rust or corrosion.
- Lubricate the with a good grade of clean petroleum oil without additives. The oil should be free flowing for the ambient temperature in which the seed tender is operating.

RECOMMENDED GRADE	TEMP, °F
SAE 5	-50 to + 50
SAE 10	-20 to + 80
SAE 20	+10 to +110
SAE 30	+20 to +130
SAE 40	+30 to +140
SAE 50	+40 to +150

- The chain must always be kept snug but not too tight. To check the tightness of the chain:
 - a. Push the chain inward, on the slack side of the chain, between the drive sprocket and rotating sprocket.
 - b. Pull the chain outward.
 - c. The distance the chain travels, side-to-side, should be between 1/8" and 1/4".
 - d. If the travel exceeds this amount, tighten the chain using the adjustment mechanism.
- Remove any dirt or debris on the chain. Dirt buildup on the roller chain and sprockets will have an abrasive effect when suspended in lubrication and can cause premature wear.



Fig 62 - Chain Drive

- Check for signs of wear on the inner surfaces of the roller chain and teeth of the sprockets.
- Inspect the chain for flexibility, making certain that each and every link joint is free to pivot.
- The roller chain will stretch and elongate over the life of the tender. A chain should be replaced if any or all of the pitches (distance from one pin to the adjoining pin) exceed 41/64".

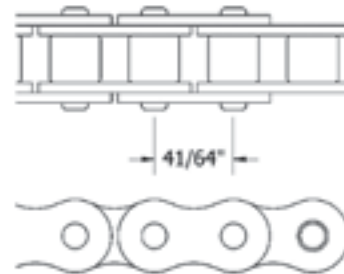

- Check the entire chain for any signs of fatigue such as cracks, loose pins, or loose bushings. Also check for corrosion or pitted surfaces. Replace any damaged chain.
- Check the sprockets for signs of wear, such as cracks, thinning of the teeth, hook-shaped teeth, or wear patterns on the sides of the teeth. Also check for corrosion or pitted surfaces. Replace any damaged sprockets.

4.3.7 Trailer Break-Away System:

Testing the Battery:

1. Disconnect the trailer plug from the tow vehicle; otherwise, you are testing the tow vehicle's battery.
2. Press the TEST button on the control box located inside the frame of the trailer.
 - The green indicator light will illuminate if the battery is fully charged.
 - If the yellow or red indicator lights illuminate, the unit's battery should be charged before towing the trailer.

IMPORTANT:

If the battery is weak or dead (red indicator, even after charging), as indicated by the indicator light, the battery must be replaced.

3. Plug the trailer into the tow vehicle. The yellow "Charging" light should be ON.
4. Test the system by pulling the pin out of the break-away switch. The battery will activate the brakes. (**Note:** Do not use this kit as a parking brake). The battery should be charged and tested prior to each trailer outing.

Charging Battery:

The battery in the break-away system is rechargeable. If the battery will not hold a charge, replace the battery.

Replacing Battery:

The battery in the break-away system is replaceable. If the battery will not hold a charge, replace the battery. Contact the OEM supplier for a replacement battery.



Fig 63 - Break-Away system control box



Fig 64 - Break-Away cable on hitch tongue

4.3.8 Remote Control Handset:

The handset is powered by two AA batteries. The handset display window indicates the remaining battery life. When batteries are new, the display indicates 100% power. As the control is used, the power decreases. When red indicator light turns ON, the batteries should be replaced immediately, or discontinue the using it.

Battery Replacement Tips:

- Check the batteries at least every six months (for low Voltage, leakage, etc.).
- Always use the correct size and type of battery. Replace old batteries with new 1.5 Volt AA, alkaline batteries.
- Always replace both batteries at the same time.
- Do not mix types, brands, or ages of replacement batteries.
- Do not install the batteries backwards. Make sure you insert the batteries with the + (plus) and – (minus) terminals aligned correctly.
- Remove the batteries from the controller if not expected to be in use for several months.
- Do not attempt to recharge a battery unless it is specifically marked “rechargeable.”
- Dispose of old batteries properly.

Battery Replacement:

1. Remove the two Phillips head screws from the cover on the back of the unit.
2. Replace the batteries, making sure they are correctly positioned.

4.3.9 Remote Control Handset to Control Panel Receiver Synchronization:

To reprogram the ID code to the receiver:

Note:

Do not interrupt this procedure before it has completed or the system may not operate correctly.

1. Turn the handset and control panel OFF.
2. Press and hold the POWER button on the handset for more than ten seconds.
 - The handset LCD display will indicate when to apply power to the control panel.
3. When directed, apply power to the receiver.
 - Green LED stays on constantly when reprogramming is in progress.
4. When the process is completed, the green LED will blink on and off.
 - Test the handset transmitter to make sure it functions properly.

4.3.10 Changing Handset Sleep Time:

To change the sleep time on the handset:

1. With the handset off, press and hold ENGINE STOP, CONVEYOR STOP and POWER buttons.
2. Wait for a few seconds, then release the buttons.
3. The green and red LEDs will start blinking together.
4. Use CONVEYOR INC and CONVEYOR STOP to increase/decrease the sleep time.
5. Select the desired sleep time.
6. Press POWER button to save and exit.

4.3.11 Control Panel Error Codes:



Fig 65 - Control panel

Error Code Outputs:

The receiver module can identify problems with the system in the form of an error code. Check red indicator light (a) on the receiver to diagnose system problems.

Each of the outputs from the receiver module is designed with built-in short circuit and overload protection. The outputs can also detect a no-load or broken wire condition.

These error conditions are indicated by the red LED indicator on the receiver module or the HISTOGRAM page on the optional Palm Pilot™. Refer to the Error Code Chart for explanation of the error codes. Green LED indicator light (b) will blink on the receiver during normal communication.

The ON/OFF outputs will indicate an error under no load or broken wire status if NOT activated, and will detect a short if activated.

Table 1 - Control Panel Display Error Codes

ERROR CODE	CAUSE	SOLUTION
1	RF Communication	Transmitter is OFF. Transmitter went into sleep mode. Interference in RF communication link.
2	Wrong ID	Transmitter and receiver are not synchronized.
3	Scale Bar Fault	RS-232 communication cable between scale unit and receiver is damaged, disconnected, or the scale unit is OFF.
4	Low Battery	System voltage is below 10.5 Volts.
5	Conveyor Speed Fault	Check for short or open circuit.
6	Engine Start Fault	Check for short or open circuit.
7	Engine Stop Fault	Check for short or open circuit.
8	Conveyor Lift Fault	Check for short or open circuit.
9	Conveyor Lower Fault	Check for short or open circuit.
10	Conveyor Left Fault	Check for short or open circuit.
11	Conveyor Right Fault	Check for short or open circuit.
12	Slide Gate 1 Open Fault	Check for short or open circuit.
13	Slide Gate 1 Close Fault	Check for short or open circuit.
14	Slide Gate 2 Open Fault	Check for short or open circuit.
15	Slide Gate 2 Close Fault	Check for short or open circuit.

Note:

Error codes are invalid during manual operation.

Table 2 - Control System Wiring Locations

PIN	DESCRIPTION
A	Conveyor Speed CR Proportional Output - Orange/Black
B	Engine Start Output
C	Engine Stop Output
D	Conveyor Lift Output - Red
E	Conveyor Lower Output - Blue
F	NC
G	NC
H	Power
J	NC
K	NC
L	Conveyor Left Output - White
M	Conveyor Right Output - Green
N	Ground
O	Slide Gate One Open Output – Red/Black
P	Slide Gate One Close Output – Blue/Black
Q	Slide Gate Two Open Output – Green/Black
R	Slide Gate Two Close Output- Black/White
S	NC
T	NC
U	NC
V	NC
W	NC
X	NC



Fig 66 - Weigh Scale junction box

4.3.12 Weigh Scale Load Cells:

Four load cells are used with the tenders equipped with a weigh scale system. There is no maintenance required for these load cells. If the seed tender does not seem to be functioning correctly, refer to the Troubleshooting section, call an authorized dealer, or call the factory.



Fig 67 - Weigh scale load cell location

Note:

Load cells on the 240 RT and 375 RT are contained within the tender's frame. Figure 67 is for instructional purposes only and does not represent the actual design of the tender itself.



Fig 68 - Weigh scale load cell

4.3.13 Axle, Trailer, Frame Bolts:

Check the axle, frame, trailer and tender hold-down bolt torque at least once per year.

4.3.14 Trailer Hitch Bolts:

The front hitch section of the seed tender is bolted to the trailer frame. This design allows the same trailer to use either a bumper hitch assembly or a gooseneck hitch. These hitch assemblies are interchangeable, if needed.

Check the trailer hitch bolt torque at least once per year.

4.3.15 Wheel Bolt Torque Requirements:
 **WARNING**
EXPLOSIVE FORCE HAZARD

To prevent injury due to possible dangerous separation of wheels from the axle, the wheel nuts must be maintained at the proper torque levels. Properly tightened wheel nuts prevent loose wheels and broken studs.

Initially check the wheel bolt torque at 10, 25, and 50 miles, as well as after each wheel removal.

Note:

Torque wrenches are the best method to ensure the proper amount of torque is being applied to a wheel nut.

1. Tighten the wheel nuts in three stages:
 - First stage: 20 to 25 foot pounds.
 - Second stage: 50 to 60 foot pounds.
 - Third stage: 90 to 120 foot pounds.
2. Tighten the wheel nuts in a clockwise, cross-axle alternating pattern.

Also, check conveyor tube and bearing bolts.

4.3.16 Tires:

Check the tires for normal and/or abnormal tire wear. Replace tires that are damaged or worn beyond normal tread life.

Replace the tires with Meridian® part number 18131 or an equivalent tire:

3T235/80R16

TR643

Load Range E

For Trailer Service Only

4.3.17 Wheel Bearings:

Each axle is equipped with a grease zerk under the center dust cap of the wheel. Add grease sparingly to the wheel bearings, using only wheel bearing grease. The wheel bearings should be repacked annually. Check for excessive end play and tighten, if necessary.

IMPORTANT:

Over greasing wheel bearings can cause them to overheat, resulting in damage and/or failure.

4.3.18 Welding Repairs:

Repair welding must be done with care and with procedures that may be beyond the capabilities of the ordinary welder.

Before performing any type of welding repair to the seed tender, contact Meridian® for approval.

IMPORTANT:

Anyone performing a welding repair should be certified in accordance to the American Welding Society (AWS) standards.



This page intentionally left blank

4.5 ORDERING PARTS

Always give the Model Number and Serial Number when ordering parts.

To get your parts promptly the following information will be required:

- The part name and number
- Your Name, Address, Town, State/Province, Country
- Complete information for shipping

Confirm all phoned in orders in writing. If Purchase Orders are required please note the number on the written order.

Unless claims for shortages or errors are made immediately upon receipt of goods, they will not be considered.

Inspect all goods received immediately upon receipt. When damaged goods are received, insist that a full description of the damage is made with the carrier against the freight bill. If this is insisted upon, full damage can be collected from the transport company.

No responsibility is assumed for delay or damage to merchandise while in transit. Dealers responsibility ceases upon delivery or pickup of shipment from or to the transportation company. Any freight damage claims must be made with the transportation company, not with the dealer.

Section 5: TROUBLESHOOTING

In the following trouble shooting section, we have listed many of the problems, causes and solutions to the problems which you may encounter.

If you encounter a problem that is difficult to solve, even after having read through this trouble shooting section, please contact your authorized dealer, distributor or the factory. Before you call, please have this Operator's Manual and the serial number from your machine ready.

Problem

Possible Cause	Possible Solution
----------------	-------------------

Engine will not start

No fuel	Fill the fuel tank
Low engine oil	Fill the crankcase with oil
Cold engine	Open choke
Ignition key switch off	Turn ignition key switch on
Battery dead	Recharge or replace battery
Engine problem	Refer to engine manual

Conveyor will not start

Not rotating	Start engine and increase speed above 1400 RPM
Drive pulley connection or conveyor coupling	Repair or replace
Drive belt slipping	Increase belt tension
No hydraulic oil in reservoir	Check oil level

Electrical or hydraulic are not working properly

RC handset transmitter power is OFF	Turn power ON
Control panel power is OFF	Turn power ON
Battery cable or battery	Check battery cable and make sure battery is fully charged
Error in the control system	Check LED Error Code light
Improper ground	Check for proper grounding electrical circuit
Hydraulic valve or motor	Ensure hydraulic pump is working properly and hydraulic tank is filled with oil
Intermittent function	Check receiver antenna for damage and proper connection. Loose connector at the valve coil



This page intentionally left blank

Section 6: REFERENCE

For information not included here, or for a digital copy of this manual, please call your dealer, or Meridian Manufacturing Inc. directly for assistance. Visit our website at: www.meridianmfg.com.

Note:

The drawings and schematics are contained in a separate parts book.

6.1 SPECIFICATIONS

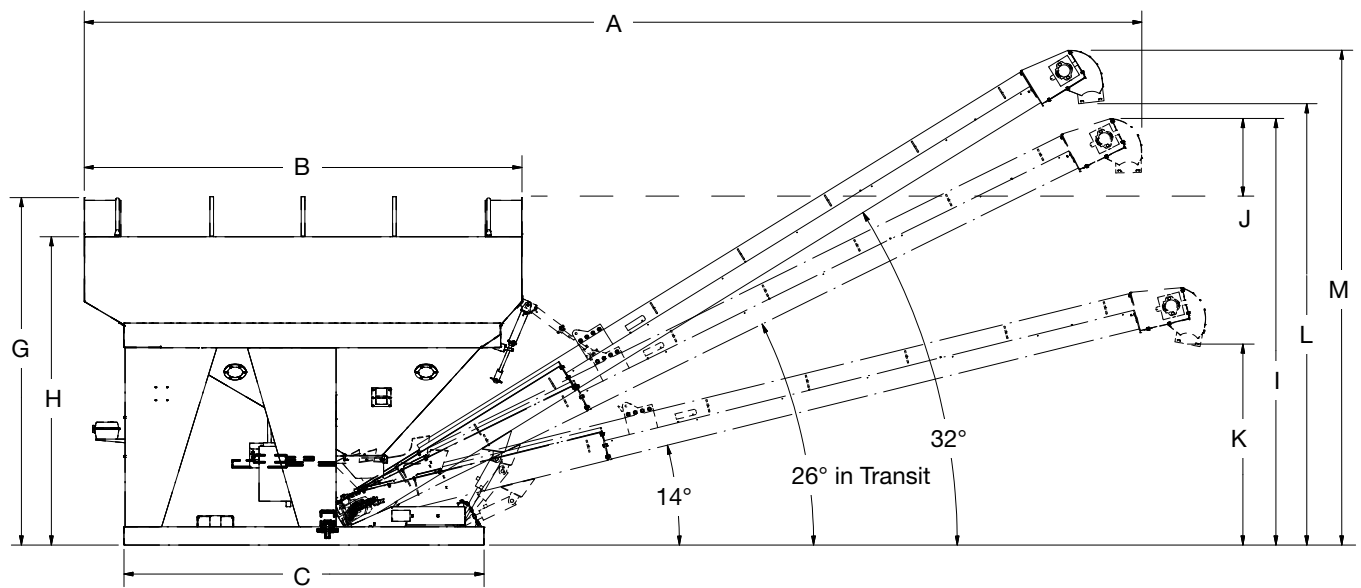
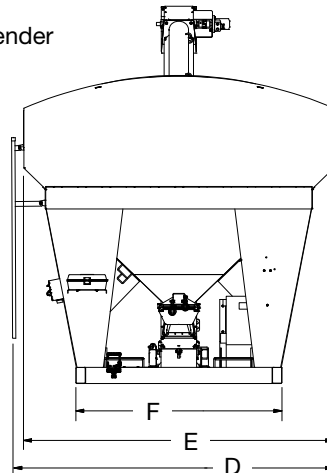

Fig 69 - Measurements of 240 RT tender



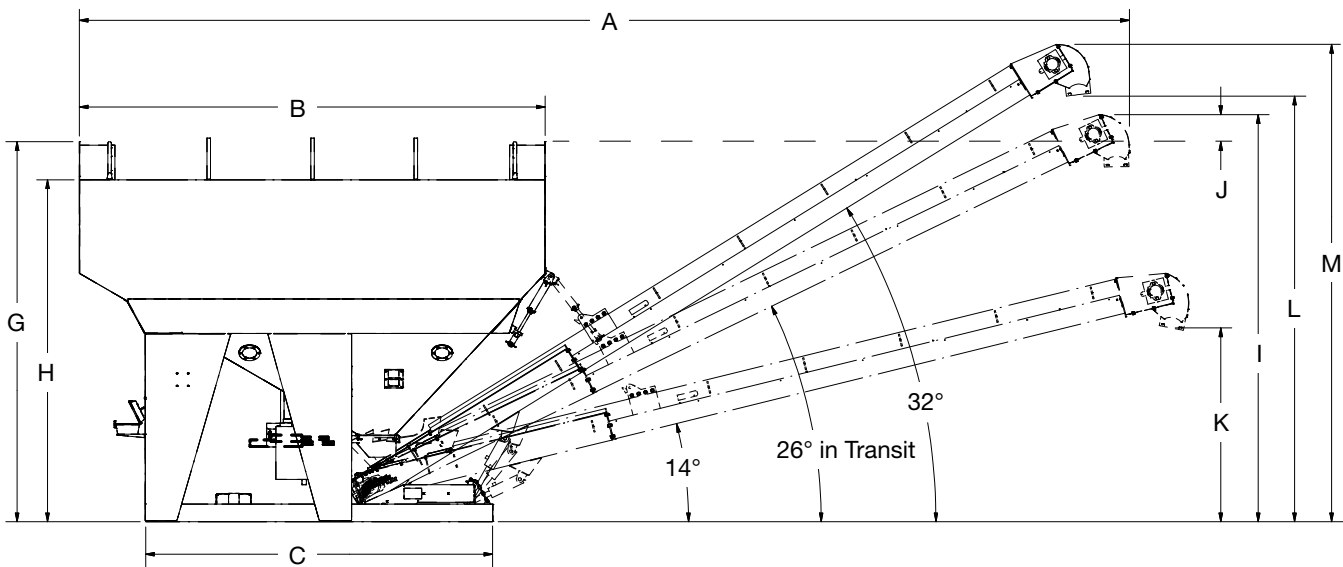

Fig 70 - Measurements of 375 RT tender

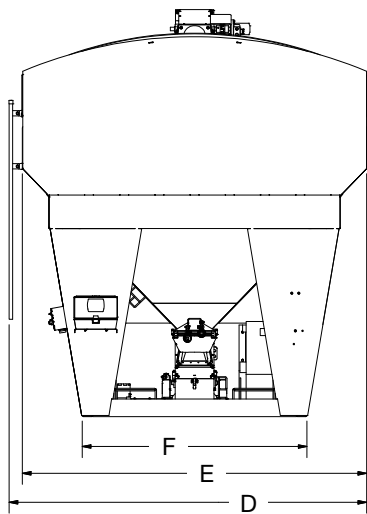

Table 3 - Tender Specifications

		240 RT	375 RT
A	Overall Length	24' 1-1/2"	24' 10"
B	Main Body Length	9' 11-3/4"	11' 1/4"
C	Base Length	8' 2-1/2"	8' 2-1/2"
D	Tender Width	8' 3-3/4"	8' 5-1/2"
E	Hopper Width	8'	8' 1-3/4"
F	Base Width	5' 3-3/4"	5' 3-3/4"
G	Tender Height	7' 11"	8' 11-3/4"
H	Compartment Height	7' 1/2"	8' 1"
I	Conveyor Height in Transport (26°)	9' 9-3/4" (6") 9' 9-1/4" (8")	9' 7-1/2" (6") 9' 6-1/4" (8")
J	Conveyor above Tender	1' 9-1/2" (6") 1' 9-1/4" (8")	7-3/4"
K	Discharge Height at Minimum Unload (14°)	4' 7" (6") 4' 3-1/2" (8")	4' 7" (6") 4' 3-1/2" (8")
L	Discharge Height at Maximum Unload (32°)	10' 3/4" (6") 9' 10" (8")	10' 3/4" (6") 9' 10" (8")
M	Conveyor Height at Maximum Unload (32°)	11' 3-1/2" (6") 11' 4-3/4" (8")	11' 3-1/2" (6") 11' 4-1/2" (8")

Heights with two dimensions are for 6" and 8" conveyor models.
 ST Trailer and Scales: Add 24" to height.
 T14000ST Trailer: Add 19" to height.

6.2 BOLT TORQUE

The tables shown below give correct torque values for various bolts and capscrews. Tighten all bolts to the torques specified in chart unless otherwise noted. Check tightness of bolts periodically, using bolt torque chart as a guide. Replace hardware with the same strength bolt.

Table 4 - English Torque Specifications

BOLT DIA. "A"	BOLT TORQUE*					
	SAE 2 (Nm) (ft-lb)		SAE 5 (Nm) (ft-lb)		SAE 8 (Nm) (ft-lb)	
1/4"	8	6	12	9	17	12
5/16"	13	10	25	19	36	27
3/8"	27	20	45	33	63	45
7/16"	41	30	72	53	100	75
1/2"	61	45	110	80	155	115
9/16"	95	60	155	115	220	165
5/8"	128	95	215	160	305	220
3/4"	225	165	390	290	540	400
7/8"	230	170	570	420	880	650
1"	345	225	850	630	1320	970

Table 5 - Metric Torque Specifications

BOLT DIA. "A"	BOLT TORQUE*			
	8.8 (Nm) (ft-lb)		10.9 (Nm) (ft-lb)	
M3	0.5	0.4	1.8	1.3
M4	3	2.2	4.5	3.3
M5	6	4	9	7
M6	10	7	15	11
M8	25	18	35	26
M10	50	37	70	52
M12	90	66	125	92
M14	140	103	200	148
M16	225	166	310	229
M20	435	321	610	450
M24	750	553	1050	774
M30	1495	1103	2100	1550
M36	2600	1917	3675	2710

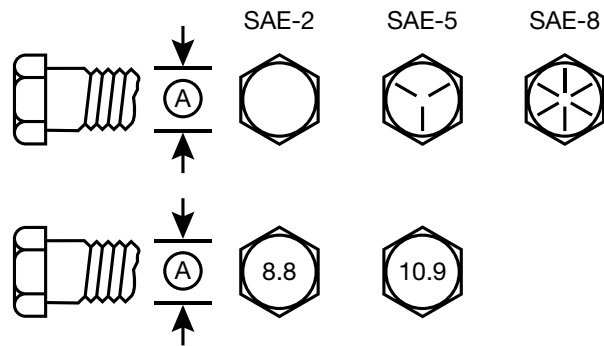

Torque figures indicated above are valid for non-greased or non-oiled threads and heads unless otherwise specified. Therefore, do not grease or oil bolts or capscrews unless otherwise specified in this manual. When using locking elements, increase torque values by 5%.

* Torque value for bolts and capscrews are identified by their head markings.

This page intentionally left blank

LIMITED WARRANTY STATEMENT

Meridian Manufacturing Inc. (hereinafter referred to as Meridian) warrants all products sold hereunder to be free from defects in manufacturing and workmanship, under normal and proper storage, service, and use, for a period of 2 (TWO) years: the first year - full warranty on Parts and Labor, the second year - Parts Only; when used in accordance with the manufacturer's guidelines, from the first date of use. Our liability extends only to the repair or replacement of the defective parts. No labor charge for the correction of the defect, by repair or replacement, will be paid by Meridian, unless prior written authorization has been granted by Meridian. Units that have been in service, then sold will carry the remainder of the 2 year warranty from Meridian.

This warranty is not applicable to, and Meridian makes no warranty with respect to, any parts not installed by Meridian or its representatives.

No implied warranty shall apply beyond the aforementioned warranty period. The foregoing warranty is exclusive of all other statutory, written or oral warranties, and no other warranties of any kind, statutory or otherwise, are given or herein expressed.

Meridian will not, under any circumstance; whether as a result of breach of contract, breach of warranty, tort, strict liability or otherwise; be liable for consequential, incidental, special or exemplary damages. This includes, but not limited to: loss of profits, loss of use or damage to any property or equipment, cost of capital, cost of substitute product, facilities or services, down time costs or claim of claimant's customers. Meridian liability for all claims of any kind or for any loss or damage arising out of, resulting from or concerning any aspect of this warranty, or from the products or services furnished hereunder; shall not exceed the purchase price allocable to the specific product which gives rise to the claim. Any or all such liability shall terminate upon the expiration of the warranty set forth above.

Certain chemicals may exist in the end user's locations, which may release airborne contaminants that can directly impact the integrity of essential paint and components. Exposure of these chemicals, to components with different chemical combinations may result in significant damage to paint, decals and mechanical failure. Meridian warranty does not cover these conditions unless otherwise noted.

All Meridian products that fall under warranty and needs service must be brought back to the dealer or point of purchase, unless otherwise agreed upon by the Meridian Warranty Department.

Register your product at: www.meridianmfg.com

For warranty information, email: warrantyusa@meridianmfg.com | phone: (800) 437-2334

WARRANTY REQUEST PROCEDURE

1. The product must be registered with Meridian Manufacturing Inc.
2. The purchaser must contact the dealer, from where the unit was purchased, immediately upon discovery of any defects.
3. A completed Warranty Request (Claim) Form must be submitted by the dealer to the Meridian's warranty representative for review and any subsequent course of action.
 - Warranty requests must be completed with ALL required information in order it to be considered for approval.
 - Send photographs of the entire piece of equipment, and of the specific area of concern.
4. Warranty repair work will only be performed by Meridian or an approved representative of Meridian. Warranty work completed prior to Meridian's approval will NOT be honoured. Failure to follow this procedure may affect any or all of this warranty.
5. All warranty requests will be adjudicated at the sole discretion of Meridian and in accordance with the terms and conditions of the warranty.



(800) 437-2334 | www.meridianmfg.com | tenders@meridianmfg.com